

Controlling airborne contaminants at work

A guide to local exhaust ventilation (LEV)



**HSG258 (Third edition)
Published 2017**

This is a free-to-download, web-friendly version of HSG258 (Third edition, published 2017). This version has been adapted for online use from HSE's current printed version.

You can buy the book at <https://books.hse.gov.uk/> and most good bookshops.

ISBN 978 0 7176 6613 3

Price £20.00

This book provides guidance on the design of new local exhaust ventilation (LEV) equipment. It describes the principles of deciding on, designing, commissioning and testing effective LEV.

This guidance is written for employers who use or intend to use LEV. The guidance will also help suppliers of LEV, managers, trade union and employee safety representatives. All of these groups need to work together to provide, maintain and use effective LEV and to reduce exposure from the inhalation of hazardous substances.

The book contains information about the roles and legal responsibilities of employers and suppliers; competence; principles of good design practice for effective LEV hoods and their classification; ducts, air movers; air cleaners; and system documentation – with checking and maintenance schedules and the marking of defective equipment.

It also includes guidance on the specification of LEV; commissioning; zone marking; the user manual and logbook; testing and hood labels.

This third edition has been updated and contains minor amendments and clarifications, but the advice is broadly unchanged and includes the updates made in the second edition based on feedback from industry.



Published by TSO (The Stationery Office), part of Williams Lea Tag,
and available from:

Online

<https://books.hse.gov.uk/>

Mail, Telephone, Fax & E-mail

TSO

PO Box 29, Norwich, NR3 1GN

Telephone orders/General enquiries: 0333 202 5070

Fax orders: 0333 202 5080

E-mail: customer.services@tso.co.uk

Textphone 0333 202 5077

TSO@Blackwell and other Accredited Agents

Published with the permission of the Health and Safety Executive on behalf of the Controller of Her Majesty's Stationery Office.

© Crown copyright 2017

First published 2008

Second edition 2011

Third edition 2017

ISBN 978 0 7176 6613 3

This information is licensed under the Open Government Licence v3.0. To view this licence, visit <http://www.nationalarchives.gov.uk/doc/open-government-licence/> **OGL**

Any enquiries regarding this publication should be sent to: copyright@hse.gov.uk

Some images and illustrations in this publication may not be owned by the Crown and cannot be reproduced without permission of the copyright owner. Where we have identified any third party copyright information you will need to obtain permission from the copyright holders concerned. Enquiries should be sent to copyright@hse.gov.uk

Printed in the United Kingdom for The Stationery Office.

J003398017 c3 11/17

This guidance is issued by the Health and Safety Executive. Following the guidance is not compulsory, unless specifically stated, and you are free to take other action. But if you do follow the guidance you will normally be doing enough to comply with the law. Health and safety inspectors seek to secure compliance with the law and may refer to this guidance.

Contents

| | |
|--|-----|
| Chapter 1 About this book | 4 |
| Chapter 2 Introduction to LEV, roles and responsibilities | 6 |
| Chapter 3 Properties of airborne contaminants | 12 |
| Chapter 4 Processes and sources | 16 |
| Chapter 5 Preparing a specification | 21 |
| Chapter 6 Hood design and application | 27 |
| Chapter 7 Designing the rest of the system | 50 |
| Chapter 8 Installing and commissioning | 71 |
| Chapter 9 User manual and logbook | 80 |
| Chapter 10 Thorough examination and test | 84 |
| Appendix 1 Legal requirements | 92 |
| Appendix 2 Selecting a 'control benchmark' and 'control requirement' | 95 |
| Glossary | 99 |
| Useful contacts | 105 |
| References and further reading | 107 |
| Further information | 111 |

Chapter 1 About this book

Introduction

1 Thousands of British workers contract occupational lung diseases such as occupational asthma and chronic obstructive pulmonary disease each year. Many people die or are permanently disabled by these conditions and are unable to work. People develop these diseases because they breathe in too much dust, fume or other airborne contaminants at work, often because control measures do not work well enough. Most industries are affected, including woodworking, welding, paint-spraying, stonemasonry, engineering and foundry work.

2 This guidance explains how local exhaust ventilation (LEV) can help employers effectively control exposure to gas, vapour, dust, fume and mist in workplace air by extracting the clouds of contaminant before people breathe them in. It describes the principles of design, installation, commissioning, testing and examination of proportionate 'ventilation controls'.

Who is this book aimed at?

3 Where employers use or intend to use LEV they must ensure that it is appropriate for the task, installed and operated correctly and subsequently maintained so it continues to operate as when originally installed. Suppliers of LEV can play an important role in helping the employer with the design, installation and maintenance of the equipment. This guidance is therefore intended to help employers and suppliers as well as managers, trade union and employee safety representatives to work together to provide effective LEV so that workers are not breathing in hazardous substances. Different chapters will be more appropriate for different audiences.

4 HSE has evidence that employers are often unaware that their workers are being exposed to hazardous substances or that existing controls may be inadequate. The problems include:

- sources of exposure are missed;
- employers (and suppliers) are over-optimistic about the effectiveness of the controls;
- existing controls have deteriorated;
- the controls are not used correctly.

5 Suppliers can help employers by:

- assisting correct LEV choice;
- providing LEV that is fit for purpose, is shown to work and continues to work;
- questioning whether existing controls are working well enough.

6 Employers should have a systematic and critical approach to controls, working with designers, suppliers and employees to avoid expensive mistakes and control exposure effectively.

What does this book include?

7 This third edition has been updated, with minor amendments and clarifications, but the advice is broadly unchanged. It includes information on:

- LEV and other ventilation as part of the measures needed to control exposure;
- the roles and legal responsibilities of suppliers, employers and service providers, such as those who install, commission, maintain, examine and test LEV;
- the levels of competence people need;
- principles for design and/or supply of effective LEV, including matching the LEV to the process and the source;
- hood classification – enclosing, receiving and capturing;
- installation and commissioning;
- having a user manual and a logbook with every LEV system;
- information that the supplier should provide on checking and maintenance;
- a description of thorough examinations and tests.

8 There is also a glossary of useful terms and 'Useful contacts' and 'References and further reading' sections.

9 This book does not cover specialised topics such as biological agents; radioactive substances; pharmaceutical containment; confined spaces and air blowers; refuges (clean rooms in contaminated environments); or cleaning systems. However, the principles of LEV design often apply in such fields.

Chapter 2 Introduction to LEV, roles and responsibilities

Key points

- The employer (the LEV owner) must ensure controls are adequate.
- Everyone in the LEV supply chain must be competent.

What is local exhaust ventilation?

10 LEV is an engineering control system to reduce exposures to airborne contaminants such as dust, mist, fume, vapour or gas in a workplace (Figure 1). Most systems, but not all, have the following:

Hood: This is where the contaminant cloud enters the LEV.

Ducting: This conducts air and the contaminant from the hood to the discharge point.

Air cleaner or arrestor: This filters or cleans the extracted air. Not all systems need air cleaning.

Air mover: The 'engine' that powers the extraction system, usually a fan.

Discharge: This releases the extracted air to a safe place.

11 All the components that may be part of the LEV system should be identified, for example:

- parts of equipment such as the machine casing or guards if they also serve as a component part of the extraction to control emissions;
- flues from hot processes, eg furnaces or ovens;
- systems to replace extracted air (make-up air), particularly where large ventilated booths extract large volumes of air from the workroom.

Roles and responsibilities

12 This book describes the principles of LEV design and application and this chapter describes the knowledge, skills and experience ('competence') required for each field of LEV practice (see Figure 2).

Employers

13 The employer is the 'system owner' and is the client for a new or redesigned LEV system. Employees, as process operators or 'LEV users', should make full and proper use of any LEV provided and report any faults.

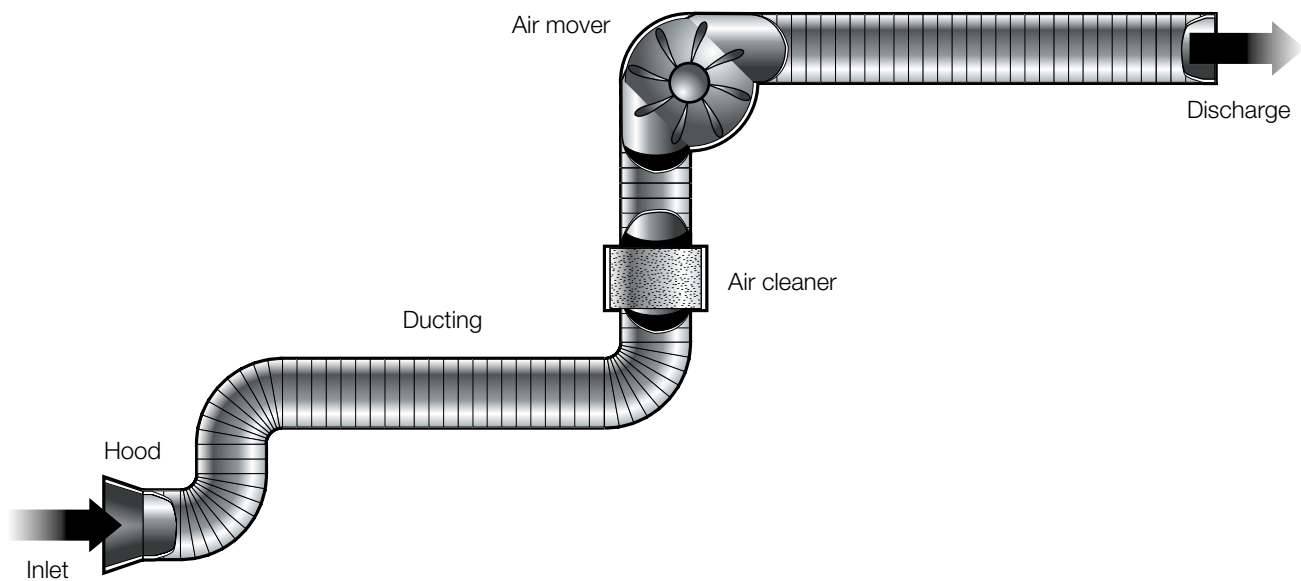

Figure 1 Common elements of a simple LEV system

| LEV owner | LEV supplier* | LEV service provider* |
|-----------------------------|---------------|-----------------------|
| Employer (client) | Designer | Commissioner |
| Employee (process operator) | Installer | Maintenance engineer |
| Employee (routine checks) | | Examiner |

* Roles can overlap.

Figure 2 Who's who in LEV supply and ownership

What employers should do before applying LEV

14 The employer must consider other control options and use them where appropriate (see HSE leaflets *Working with substances hazardous to health*¹ and *Clearing the air*²) before applying LEV. In some circumstances, LEV may not be a reasonably practicable control as there may be many sources or extensive contaminant clouds that are too large for LEV alone to control. The other control options are:

- eliminate the source;
- substitute the material being used by something safer;
- reduce the size of the source;
- modify the process to reduce the frequency or duration of emission;
- reduce the number of employees involved with a process;
- apply simple controls to fully or partly enclose the process, eg fitting lids to equipment.

If LEV is appropriate, what employers should be aware of

- The key properties of airborne contaminants.
- How gases, vapours, dusts and mists arise.
- How contaminant clouds move with the surrounding air.
- The processes in the workplace which may be sources of airborne contaminants.
- The needs of the operators working near those sources.
- Whether LEV alone can provide adequate control or, if not, what additional control measures will be required.
- How to prepare a specification for the LEV designer.
- What to tell the LEV supplier.

15 When applying LEV employers should be aware of:

- the general principles of hood design and application;
- the need for airflow indicators and other instrumentation;
- capture zones, working zones and breathing zones;
- the general principles of ductwork, air movers and air cleaners and how they interact;
- the principles of how to discharge contaminated air safely and replace it with clean air;
- the process of installing and commissioning the LEV system;
- the usefulness of a user manual and logbook;
- the requirement for thorough examination and test of LEV.

16 The employer must use a competent person to provide 'LEV services'. The competent person can be either an outside contractor or a competent employee of the LEV owner (the employer).

LEV routine checks

17 The people who carry out routine checks of the LEV system are usually employees or supervisors, but may be service providers.

These checks require understanding

- The parts of an LEV system and their function.
- How the LEV system should be used.
- How to recognise a damaged part.
- The simple checks that can confirm the LEV system is delivering its design performance and continuing to provide control as required and identified in the risk assessment and control strategy.

LEV suppliers and designers

18 LEV suppliers provide goods (an LEV system) and may then act as a service provider. Designers interpret the requirements of the employer and advise on an effective LEV system which is capable of delivering the required control.

What suppliers and designers should know

- Their role and legal responsibilities (see Appendix 1).
- How to liaise effectively with the employer and installer.
- Hazardous substances to be controlled.
- The principles of LEV hood design.
- How to apply hood design to the processes and sources requiring control.
- How to design LEV for ease and safety of checking and maintenance.
- The specifications for airflow, duct, filter, air mover, air cleaner, discharge, instrumentation and alarms.
- The specification for in-use performance checks.
- How to prepare an LEV user manual with schedules for maintenance and statutory thorough examination and test.
- How to prepare a logbook for the system, recording checks, replacing parts etc.

LEV installers

19 LEV installers work with commissioners (see paragraph 21) to ensure the equipment supplied provides adequate control of the contaminant. The installer may be the design company, a service provider, or even the employer (if competent).

What installers should know

- How to install LEV systems safely.
- The basic principles of LEV hood design and proper application.
- How to install according to the specified design.
- How to ensure LEV delivers intended performance.
- How to liaise effectively with the designer and employer.

LEV service providers

20 Service providers offer services such as installation, commissioning, maintenance and thorough examination and tests.

LEV commissioners

21 LEV commissioners work with installers to make sure the equipment supplied provides adequate control of the contaminant.

What commissioners should know

- Their role and legal responsibilities (see Chapter 8).
- How to liaise and communicate with the employer and employees.
- How to check that the LEV system is delivering its design performance.
- How to specify and describe the performance of the LEV system.
- How to check that exposure is effectively controlled and the LEV system is performing as designed.
- What to include in the LEV commissioning report as an adequate benchmark against which to compare future performance.

LEV maintenance and repair engineers

22 LEV maintenance and repair engineers are usually service providers, but sometimes an employee can carry out the work.

What maintenance and repair engineers should know

- How to recognise and assess hazards.
- How to follow safe systems of work.
- To warn operators that maintenance is under way.
- How the LEV system works.
- What assessment methods to use to check the LEV system's performance is maintained.
- What routine maintenance is needed (following instructions such as those in a 'user manual').
- What measures of performance to record and who to report to if there are problems.

LEV examiners – statutory thorough examination and test

23 LEV examiners responsible for carrying out the thorough examination and test are usually service providers but this can be carried out by a competent person who could be an employee.

What examiners should know

- The parts of an LEV system and their function.
- The legal requirements for the thorough examination and testing of LEV systems.
- How to recognise a damaged part from a visual inspection.
- The purpose of, and how to use, the measuring and assessment instruments and techniques.
- The most suitable instrument to test the performance of each part of the LEV system.
- The standard to which each part of the LEV system should perform.
- How to recognise when a part of the LEV is performing unsatisfactorily, based on the measurements taken and assessment methods used.
- How to check whether the LEV is effective in reducing airborne contaminant emission and operator exposure.
- How to collate and record information in a clear, concise and usable way.
- How to work safely with the LEV plant and the hazards associated with it.

Legal responsibilities

24 People who supply, own and use LEV have legal duties.

- The employer of the people being protected by the LEV has legal responsibilities under the Health and Safety at Work etc Act 1974 (the HSW Act),³ the Control of Substances Hazardous to Health Regulations 2002 (as amended) (COSHH)⁴ and the Management of Health and Safety at Work Regulations 1999 (MHSWR).⁵ There are also special provisions for employers in safety data sheets under REACH⁶ (see paragraphs 82–86).
- LEV suppliers have legal responsibilities under the HSW Act and the Supply of Machinery (Safety) Regulations 2008 (SMSR),⁷ including 'essential health and safety requirements'.

- If an employer is using a substance that could form an explosive atmosphere they must consider their responsibilities under the Dangerous Substances and Explosive Atmospheres Regulations 2002 (DSEAR),⁸ and the supplier of equipment for use in an explosive atmosphere their responsibilities under the Equipment and Protective Systems Intended for Use in Potentially Explosive Atmospheres Regulations 1996.
- Service providers have legal responsibilities under the HSW Act and the Construction (Design and Management) Regulations 2015 (CDM 2015).⁹

25 For more about legal responsibilities, see Appendix 1.

Competence

26 Another legal requirement under MHSWR and COSHH is 'competence'. This means people having sufficient training, knowledge and experience to carry out the job they are employed to do. Competence requirements apply to whoever:

- designs or selects control measures;
- checks, tests and maintains control measures;
- supplies goods and services to employers for health and safety purposes.

27 The requirement for competence for suppliers of goods and services means that the extent and depth of their knowledge and capability must be sufficient to assess and solve the problems they are likely to meet.

28 The more complex a control scenario is and the more serious the results of failure, the greater the degree of competence required. For example:

- Simple, routine, specified work requires basic knowledge and training.
- Complex work requires recognised and appropriate qualifications, much greater knowledge and demonstrated success at applying this knowledge to a variety of problems.

29 Many trades recognise levels of competence based on qualifications and tests of capability, as well as experience of successful problem-solving over a number of years. See Appendix 1 for more information on becoming 'competent'.

30 The employer decides who to employ or consult and needs to be an 'intelligent customer' to get the best result. HSE has produced simple guidance to help the employer choose a supplier when they are considering installing LEV (see HSE leaflet *Clearing the air*). Suppliers need to prepare their information to respond to this approach.

Training courses

31 Those individuals wishing to improve their LEV knowledge and skills should consider attending a suitable training course leading to qualifications such as those provided by the Institution of Local Exhaust Ventilation Engineers (ILEVE) or the British Occupational Hygiene Society (BOHS).

32 See Appendix 1, paragraph 17 for more information.

Chapter 3 Properties of airborne contaminants

Key points

- Gases, vapours, dusts, fumes and mists arise differently.
- Airborne contaminants move in the air in which they are mixed or suspended.

33 This chapter describes the behaviour of airborne contaminants and removes some common misconceptions.

Airborne contaminants

34 Air contaminants are particles, gases or vapours and combinations of these. 'Particles' include dusts, fumes, mists and fibres. Table 1 shows some of the basic characteristics of airborne contaminants.

Table 1 Some properties of airborne contaminants

| Name | Description and size | Visibility | Examples |
|---------------|--|---|--|
| Dust | Solid particles – can be supplied, eg powder-handling, or process generated, eg crushing and grinding Inhalable particle size 0.01 µm to 100 µm Respirable particle size below 10 µm | In normal light: • inhalable dust clouds are partially visible • respirable dust clouds are practically invisible at concentrations up to tens of mg/m ³ | Grain dust, wood dust, silica flour |
| Fume | Vaporised solid that has condensed Particle size 0.001 µm to 1 µm | Fume clouds tend to be dense. They are partially visible. Fume and smoke are generally more visible than equivalent concentrations of dust | Rubber fume, solder fume, welding fume |
| Mist | Liquid particles – process generated, eg by spraying Particle size ranges 0.01 µm to 100 µm but the size distribution may change as volatile liquids evaporate | As for dust | Electroplating, paint sprays, steam |
| Fibres | Solid particles – the length is several times the diameter Particle size – as for dust | As for dust | Asbestos, glass fibre |

| | | | |
|---------------|--|--|---|
| Vapour | The gaseous phase of a substance which is normally a liquid or solid at room temperature Behaves as a gas | Usually invisible At very high concentrations, a vapour-laden cloud may just be visible | Styrene, petrol, acetone, mercury, iodine |
| Gas | A gas at room temperature | Usually invisible – some coloured at high concentrations | Chlorine, carbon monoxide |

Particles

Particle size of contaminant clouds

35 The size of particles determines whether they are 'inhalable' or 'respirable':

- Particles that are small enough to be breathed in are called 'inhalable' particles. They range in size from less than 0.01 µm up to 100 µm aerodynamic diameter.
- Clouds of inhalable particles contain smaller 'respirable' particles that can penetrate deeply into the lungs. They have an upper size limit of about 10 µm.
- Particles above 100 µm are not 'inhalable' as they are too large to be breathed in. They fall out of the air and settle on the floor and surfaces near the process.

36 There are strict definitions and standardised methods for sampling inhalable and respirable particles (see *General methods for sampling and gravimetric analysis of respirable, thoracic and inhalable aerosols*¹⁰).

Visibility of particle clouds

37 What you can see is not necessarily all that is there.

- When a cloud contains mainly respirable particles it is practically invisible to the naked eye.
- When the cloud contains inhalable particles it is partially visible.
- Mist and fume clouds are more visible than the equivalent concentration of dust.

38 Most particles in dust clouds from organic material such as wood or flour are mainly inhalable, with a minor proportion of respirable particles.

39 Most particles in dust clouds from minerals (eg stone, concrete) are mainly respirable, with a minor proportion of inhalable particles. But the larger particles make up the majority of the dust weight.

40 Dutyholders should provide information about the full extent of an airborne dust cloud, as this is rarely visible. In some cases, such as when all the particles are smaller than 'inhalable', it will be completely invisible. Tyndall illumination uses the forward scattering of light to show up the cloud (see Chapter 8). Alternatively, if smoke is released into the cloud this will show up its shape, size, speed and direction.

Movement of particles in air

41 Particles in contaminant clouds move with the air in which they are suspended.

For example:

- Particles larger than 100 μm travel some distance if ejected at high speed but settle out quickly.
- Particles around 100 μm settle out of the air near the process which generated them (depending on the strength of local air movement).
- Smaller particles float and remain suspended in the air (this may be for several minutes) and move with air currents. This means that, where a process generates rapidly moving air streams (eg grinding wheels or circular saws), fine dust will be carried a long way from the source, making dust control difficult.

'Heavy dust'

42 Particle aerodynamic size, not simply the density of the parent material, determines how particles move in the air. However, many people think that dense materials produce 'heavy dust'. They therefore place LEV hoods at floor level. This does not work because:

- large particles, even of low-density material such as plastic dust, fall out of the air easily;
- small particles, even of high-density material such as lead dust, can float away in a contaminant cloud.

43 LEV should remove both suspended inhalable particles and intercept the larger particles. For some processes, eg on a woodworking saw, LEV collects and conveys both dust and chips.

Other properties of airborne particles

44 Process-generated and process-related substances (dust, fume, mist) may have abrasive or sticky properties or be liable to condense. Some may be flammable. These properties determine the design of LEV.

Abrasive or corrosive particles

45 Some particles are more abrasive than others and some are more chemically active and may attack the LEV system components. This may severely restrict the

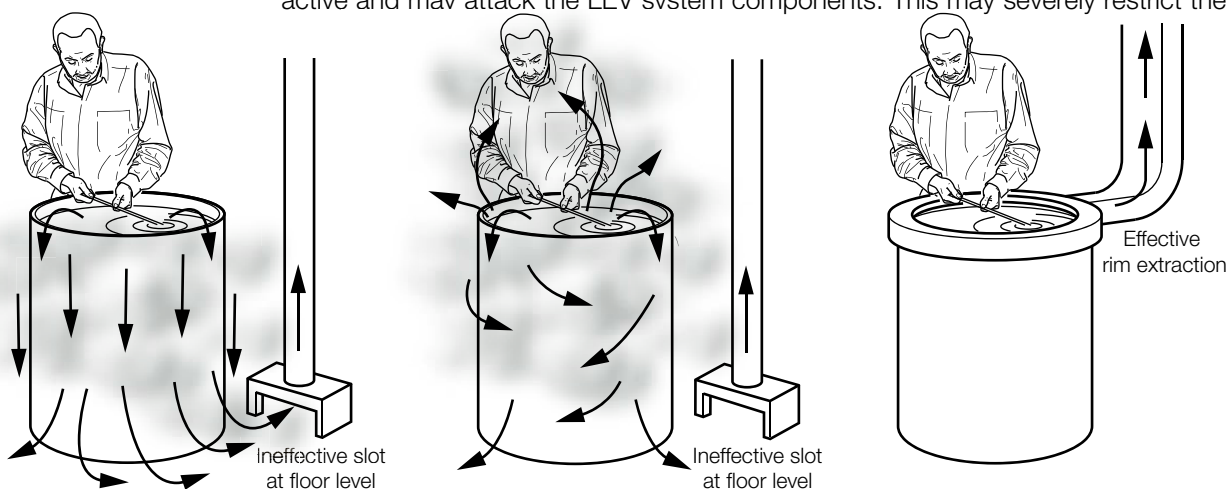

Misconception

Reality

Control solution

selection of materials used to construct the LEV system (see Chapter 7).

Figure 3 Ineffective slot at floor level and effective solution for vapour control

Sticky dust, mist and condensate

46 If a particulate is sticky or likely to condense, the LEV design should take account of this. A heavy condensate can progressively block ducts. In these circumstances, the design of the system needs to incorporate drain points for condensates and access points to ease inspection and cleaning.

Flammable or combustible substances

47 Many organic and metal dusts are combustible and LEV systems should reduce the chances of ignition and cope with a possible dust explosion. This book does not cover flammability issues such as zoning¹¹ or explosion relief.¹² Where such hazards exist, the design should take them into account – DSEAR applies.

Gas and vapour-air mixtures

- Vapours and gases move with the air in which they are mixed.
- Vapour-air and gas-air mixtures can be breathed deep into the lungs.

'Heavy vapours'

48 A saturated vapour-air mixture (cloud) exists above a liquid surface. Initially it will be heavier than air and will flow downwards, away from the source, as evaporation occurs. If circumstances inhibit dilution, for instance the vapour-air mixture flows into a confined space, the vapour-air mixture will settle. It could create a toxic risk and, depending on the material, a flammable risk.

49 In most workplaces, turbulent air movement and draughts quickly dilute a saturated vapour-air mixture (cloud) which, fairly rapidly, mixes and moves with the workroom air.

50 Figure 3 shows what commonly happens. The vapour-air cloud flows away from the top of the mixer and mixes with the workroom air, directly causing exposure. It also flows down the mixing vessel sides, all the time mixing with the room air. Some vapour-air mixture flows onto the floor. Designing and applying floor-level LEV will not effectively control worker exposure to the vapour-air cloud. Slot extraction at the lip of the vessel is one LEV control solution which could be effective.

51 Low-level LEV is often, but mistakenly, applied to control exposure to 'heavy vapours'. In practice, such controls will fail to control exposure, as Figure 3 illustrates.

52 LEV controls should be applied to contain and capture vapour-air mixtures before they can mix with the workroom air.

Chapter 4 Processes and sources

Key point

- Effective application of LEV requires good understanding of the process and sources.

53 This chapter describes how airborne contaminants arise.

What are processes and sources?

54 When developing exposure control measures, 'process' means the way airborne contaminants are generated, for example, in woodworking the processes would be cutting, shaping and sanding. The source is where the contaminant is generated by a process. Understanding the process means understanding the creation of 'sources'. This can suggest ways to modify the process to reduce the number or size of sources, and contaminant clouds. The effective application of LEV requires a good understanding of the process and the sources (see Figure 4).

55 Sources fall into four general types:

- buoyant, eg hot fume;
- injected into moving air, eg by a spray-gun;
- dispersed into workplace air, eg draughts;
- directional, of which there are at least five sub-types – see Figure 5 showing processes and sources in stonemasonry.

56 It is crucial that the LEV system designer understands how processes generate sources and how contaminant clouds flow away from source.

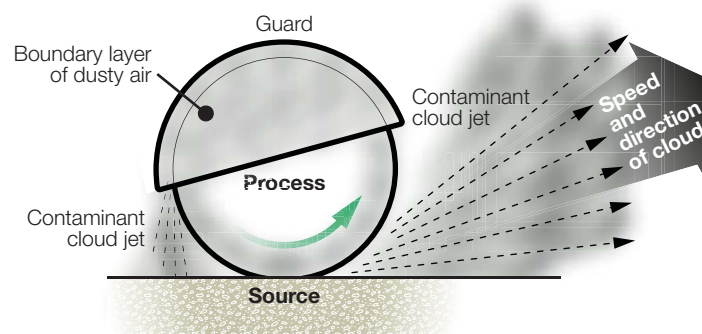

Figure 4 The source and contaminant cloud concepts for an angle grinder

Source strength

57 The strength of the source is described in terms of the area from which contaminant arises, the flow of contaminant away from the source and the concentration of contaminant within the cloud. The stringency of the control requirement is determined by a combination of the:

- source strength;
- cloud volume, shape and speed and its direction of movement;
- contaminant concentration.

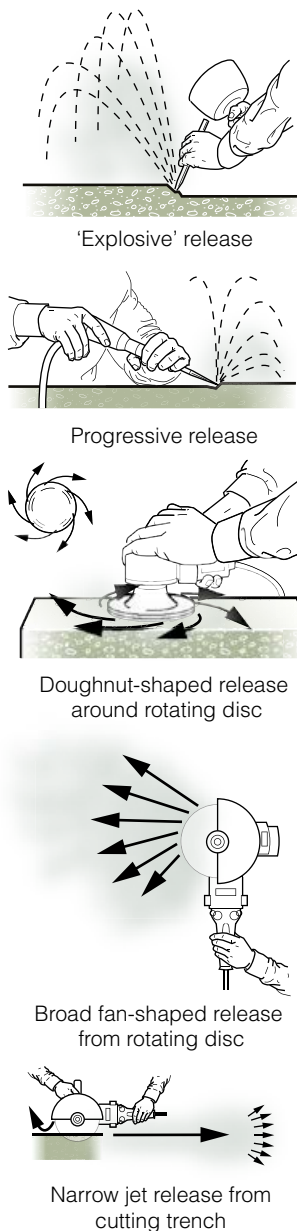

Figure 5 Processes and sources in stonemasonry

58 The further a contaminant moves away from its source, the larger the cloud grows through mixing and diffusion. Dilution reduces the concentration of the contaminant in the cloud, but it is always more effective to apply control close to the source of an airborne release because:

- the cloud volume is smaller, so it is easier to control;
- full interception of the whole cloud is more likely;
- the contaminant is less likely to enter the operator's breathing zone.

59 One process can create several sources at different stages. For example, Figure 4 shows two of the contaminant clouds arising from a grinding process; a third cloud would arise from the boundary layer, a fourth from the re-suspension of settled dust, and a fifth from dust deposited on protective clothing. Good control requires examining all of the activities and **all** of the sources that release airborne contaminant clouds.

60 Figure 6 shows an LEV system to control dust from sack emptying. But the sack disposal is uncontrolled; this source is commonly missed. Figure 7 shows a sack-tipping hood to control dust when disposing of emptied sacks.

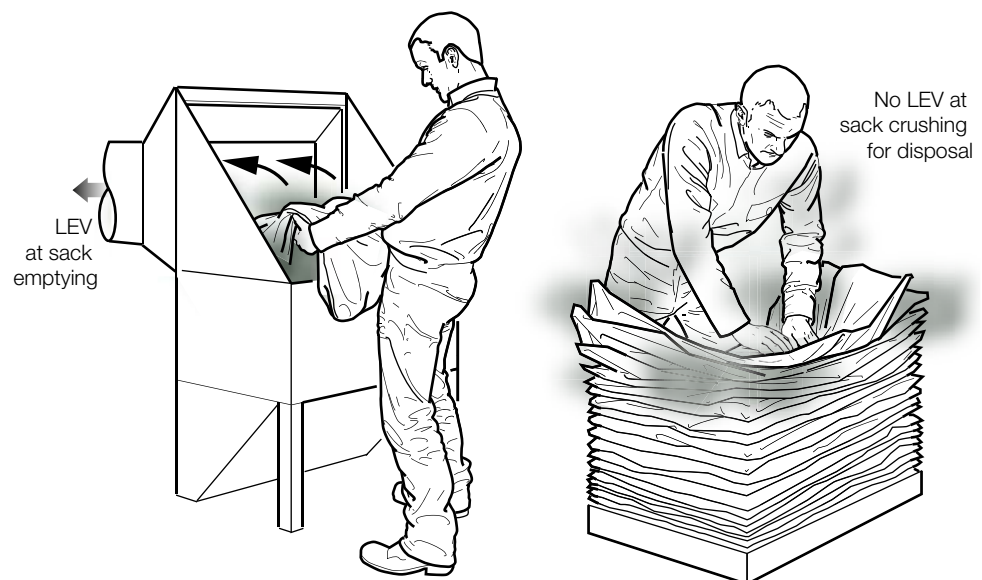

Figure 6 An LEV system to control dust from sack emptying but uncontrolled sack disposal

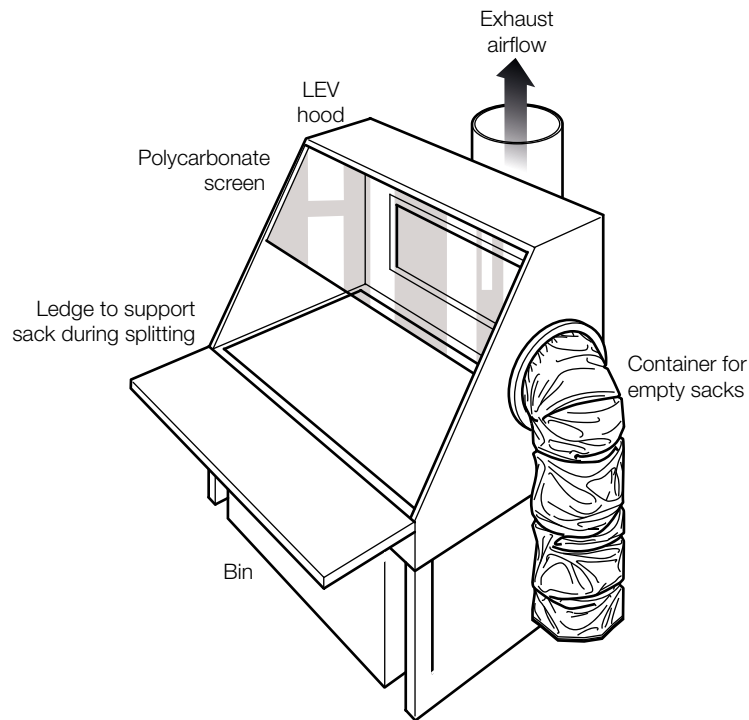

Figure 7 A sack-tipping hood to control dust from emptying and disposal of emptied sacks

Table 2 Common processes and sources

| Process | Examples | Creation mechanism(s) and source description | Form | Possible controls |
|---------------------------------|--|---|-------------------|---|
| Rotating tools and parts | Orbital, belt and disc sanders Disc cutters Circular saws and routers Lathes Drills Abrasive wheels | Rotating motion creates a fan effect The source created can be a jet (eg angle grinder with guard) or a doughnut-shaped cloud (eg disc sander) | Dust, mist | <ul style="list-style-type: none"> ● Enclose ● Strip off the 'boundary layer' of dust-laden air moving with the rotating disc ● Fit a receiving hood to the guard ● Use LVHV (low volume high velocity extraction) <p>Other controls, eg:</p> <ul style="list-style-type: none"> ● water suppression |
| Hot (and cold) processes | Furnaces and casting Soldering and brazing Welding Using liquid nitrogen | Hot sources – fume rises, expands, cools and mixes with the room air Cold sources – the contaminant sinks | Fume, vapour, gas | <ul style="list-style-type: none"> ● Enclose ● Receive the hot fume or cold contaminant cloud in a hood <p>Other controls, eg:</p> <ul style="list-style-type: none"> ● Control temperatures to reduce fume |

| Process | Examples | Creation mechanism(s) and source description | Form | Possible controls |
|--|--|--|--------------------|---|
| Free-falling, solids, liquids and powders | Falling liquid, powder or solid material Conveyor transfer of powders/solids | Falling material induces a downward flow of air If the material is a powder, there will be some shearing of fine particle-laden air at the edges of the stream. The entrained air and dust may 'splash' | Dust, vapour | <ul style="list-style-type: none"> ● Reduce the fall distance ● Enclose ● Seal gaps in conveyors ● Partially enclose transfer points |
| Displacement | Liquid, powder and granular solid transfer into a container | Materials displace their own volume of contaminated air from the container If they have fallen from a height, the induced airflow will displace even more air from the container | Dust, vapour | <ul style="list-style-type: none"> ● Partial enclosure ● Reduce the fall distance ● Minimise the container's open area ● Make the container a receiving hood <p>Other controls, eg:</p> <ul style="list-style-type: none"> ● pump liquids through pipes extending to the bottom of the container ● use a vapour recovery system |
| Spraying and blasting | Paint spraying Abrasive blasting | Compressed air pressure produces a jet that induces further air movement. The contaminant cloud is cone-shaped A paint spray gun can emit air at more than 100 m/s, extending more than 12 m | Mist, vapour, dust | <ul style="list-style-type: none"> ● Reduce air pressure, eg HVLP (high volume low pressure) spray gun ● Full, room or part enclosure <p>Other controls, eg use:</p> <ul style="list-style-type: none"> ● RPE ● water-borne abrasive ● abrasive shot, not mineral ● electrostatic methods for surface coating |
| Fracturing solids | Rock crushing Hardcore – concrete crushing Splitting (eg slate making) | Brittle fracture creates 'explosive' release of a dust cloud Material movement may then create airflow or assist the dust cloud growth | Dust | <ul style="list-style-type: none"> ● Full or partial enclosure ● Receiving, push-pull or capturing hood <p>Other controls, eg use:</p> <ul style="list-style-type: none"> ● water suppression ● supplementary RPE often needed |
| Impact and vibration | Dumping dusty sacks on a surface Machinery vibration re-suspending settled dust | Shock of the physical impact or vibration creates a dust cloud Dust-contaminated clothing can also create a dust cloud Settled dust can re-suspend in the air | Dust | <ul style="list-style-type: none"> ● Partial enclosure <p>Other controls, eg:</p> <ul style="list-style-type: none"> ● control spillage ● vacuum system for cleaning ● minimise impact and vibration |

| Process | Examples | Creation mechanism(s) and source description | Form | Possible controls |
|-------------------|--|--|------------|--|
| Compaction | Waste crushing | Compaction creates a dust cloud Material movement may then create airflow | Dust | <ul style="list-style-type: none"> ● Extract compactor in its own enclosure ● Partial enclosure |
| Handling | Sorting | Recycling waste | Dust, mist | <ul style="list-style-type: none"> ● Local air displacement |
| Machining | Milling Turning | Cooling fluid on rotating or reciprocating movement | Mist | <ul style="list-style-type: none"> ● Full enclosure ● Partial enclosure <p>Other controls, eg:</p> <ul style="list-style-type: none"> ● cold working ● increase fluid flow to increase cooling |
| Abrasion | Sanding Grinding Polishing Fettling | Mechanical removal of surfaces creates airborne dust | Dust | <ul style="list-style-type: none"> ● Capturing hood, eg downdraught or back-draught table ● Partial enclosure, eg booth ● LVHV systems <p>Other controls, eg:</p> <ul style="list-style-type: none"> ● water suppression |
| Sweeping | Dust and particulate matter | Re-suspending settled dust – a dust cloud moving in the direction of brushing | Dust | <p>Other controls, eg:</p> <ul style="list-style-type: none"> ● minimise dust leaks ● vacuum system ● wet cleaning |

See www.hse.gov.uk/lev for examples.

Chapter 5 Preparing a specification

Key point

- The employer and the supplier should work together to develop successful control solutions.

61 This chapter describes the issues to cover in developing a specification.

Exposure control measures

62 It is important to think about controlling exposure as more than just buying and installing the equipment. Effective exposure control measures consist of a mixture of control 'hardware' (engineering control) and work practices (working procedures and methods).

Control hardware

63 This means all equipment, alerts and design features to control contaminant clouds. It often includes LEV but may also include handling equipment, positioning jigs, temporary screens and elements with a design life. For example, the effectiveness of the joint seals of an enclosed conveyor may be important in minimising emissions and exposure.

Work practices

64 This covers everything that the employer and operators should know and do to achieve control when using the hardware. It includes managing the system, supervising operators and regularly reviewing and maintaining control measures.

Developing the LEV specification

65 To draw up a specification the employer should establish clearly where (and how) to apply LEV. That means identifying the processes and sources and deciding on the degree of control required.

Simple LEV systems

66 These are standard designs of LEV that are known to be effective. They are appropriate when there is no process modification necessary and the requirements are clear. Systems may even be available for supply 'off the shelf'. The employer, as client, may be competent to specify, procure, install and commission such simple LEV systems.

Complex processes

67 Complex processes (eg bespoke system and multiple extract points) often require expert design and the employer, as the client, should work closely with the expert.

68 Exposure of workers depends on a range of process factors including the source strength and how near people are to it. The designer needs the facts about the process, source and contaminant requiring control. The employer is responsible for the specification and should supply these facts as the client. This is likely to require joint effort with the designer. However, the supplier or designer may need to prompt the employer because employers do not procure new LEV very often.

Complex LEV systems

69 These are non-standard designs of LEV; Figure 8 illustrates the interdependent factors that lead to effective control. The employer and supplier should consider these factors.

Employer

70 The employer should be aware of the contaminant cloud characteristics, the requirements of the work process and the operator’s requirements – elements A, B and C in Figure 8. This information forms part of the specification for the appropriate LEV. An ‘industry standard’ of LEV makes the specification process simpler – as long as the industry standard is effective.

Supplier

71 The potential supplier can verify, or help the employer define, the contaminant cloud characteristics, the requirements of the work process and the operator’s requirements – elements A, B and C in Figure 8. The potential supplier selects a suitable LEV hood – element D in Figure 8.

Supplier and employer together

72 The supplier and employer should work together, perhaps with consultants, as a project team to develop the system. The objective is to make sure that between them they cover adequately all elements – the contaminant cloud, the work process, the operator requirements and the hood requirements.

73 Failure to cover these elements can result in ineffective or unreliable LEV.

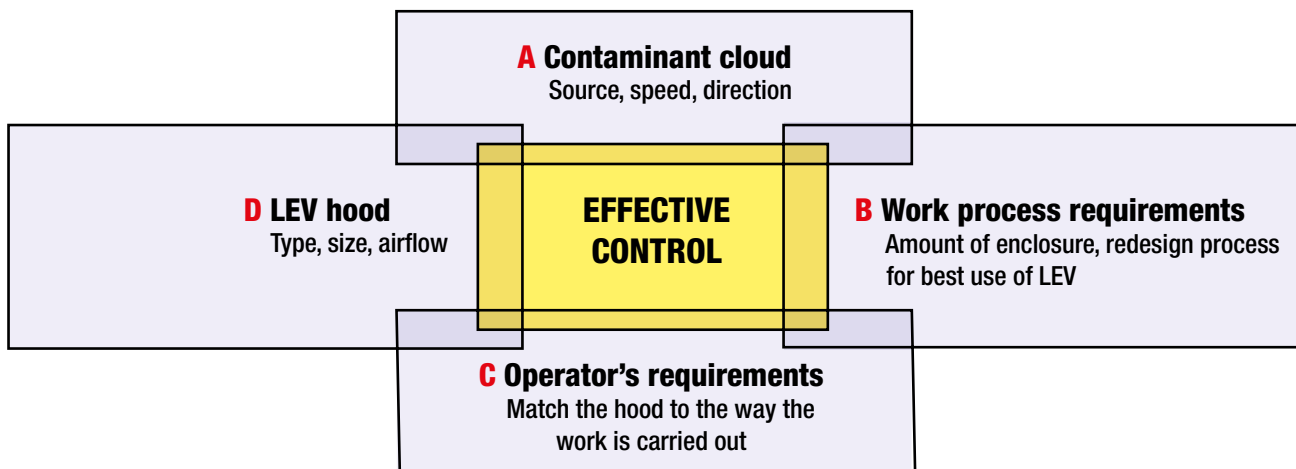

Figure 8 Developing effective LEV for more complex systems

Criteria for an LEV specification

74 The employer:

- should describe the process, the contaminant, its hazards, the sources to be controlled and exposure benchmarks (see Appendix 2). The important chemical and flammable properties of substances and products appear in the safety data sheet;
- should provide the supplier with information about other processes, discharges and activities that occur adjacent to the proposed LEV or adjacent to the process that the new LEV is to control;
- may need to take advice from a competent person concerning the type of LEV to be used, its effectiveness in controlling exposures and its costs;
- should require indicators to be fitted to show that the system is working properly;
- should require the LEV to be easy to use, check, maintain and clean, taking account of other risks, eg accessibility, skin contamination and waste removal and filter changing without spreading contamination;
- should specify that the supplier provides training in how to use, check and maintain the LEV system;
- should require that the supplier provides a user manual that describes and explains the LEV system, and how to use, check, maintain and test it, along with performance benchmarks and schedules for replacement of parts;
- should require that the supplier provides a logbook for the system to record the results of checks and maintenance.

75 It is the employer's responsibility to comply with the requirements of environmental legislation (see paragraph 227). In practice, the supplier is in a good position to advise about this.

Developing the specification

76 It may be useful for the employer to seek initial views on a specification from a number of potential suppliers. Subsequently, the employer can work with the chosen supplier on a more detailed description for the final specification.

Laying out a specification

77 To get what you need and avoid any misunderstanding with the LEV supplier it may help to ask your supplier to:

- provide technical drawings of the system;
- state the type of hood for each source, its location or position, face velocity, static pressure;
- include information on any constraints, eg the maximum number of hoods in use at any one time;
- describe the ducts – material, dimensions, transport velocity (if appropriate) and volume flow rate;
- include details of how the airflows in different branches of the LEV will be balanced;
- describe any air cleaner – specification, volume flow rate and static pressure ranges at inlet, outlet and across the cleaner;
- describe the fan or other air mover – specification, volume flow rate, static pressure at inlet, and direction of rotation of fan;
- provide information on air cleaner efficiency and sensors for systems that return air to the workplace;
- describe the indicators and alarms to be provided in the system;

- allow for the provision of suitable instructions for the installer and the commissioner of the equipment;
- allow for the provision of adequate training in using, checking and maintaining the LEV system;
- allow for the provision of suitable instructions for the user, the maintainer and the examiner of the LEV system. This will include the provision of a logbook.

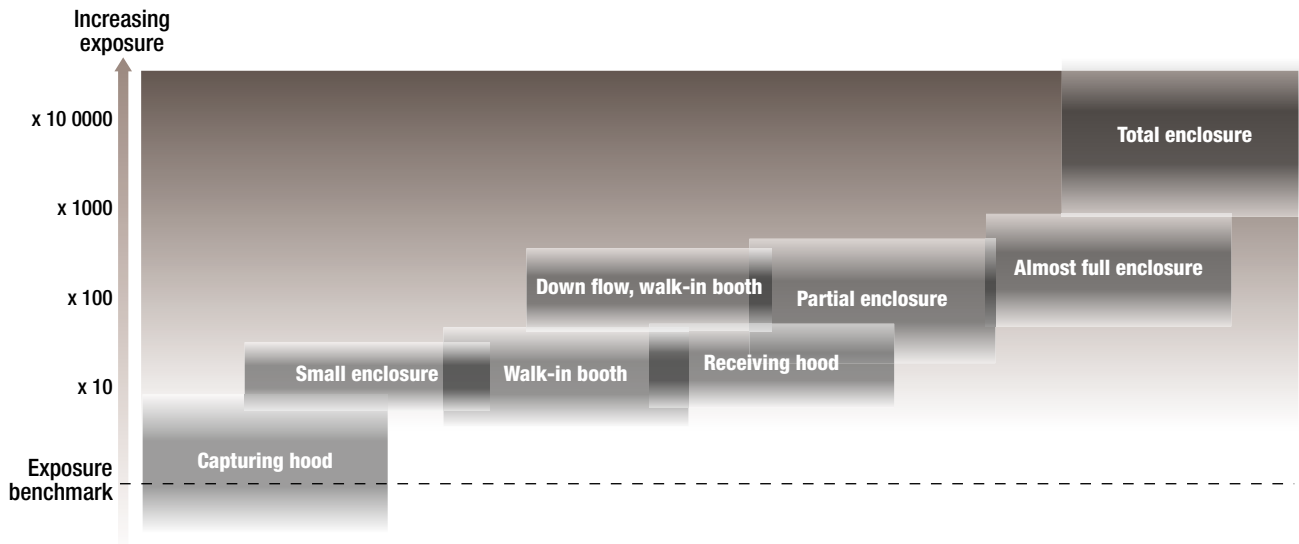

Figure 9 Effectiveness of various types of LEV

78 The designer needs to understand how effective LEV is in each specific situation. It should be capable of adequately controlling the contaminant cloud. For example, an LEV hood capable of reducing exposure 10-fold is unsuitable to control a source capable of emission at 50 times a benchmark exposure value. However, there is limited information on the effectiveness of LEV. Figure 9 proposes some indicative ranges for the effectiveness of various types of LEV.

Other issues to help produce the specification

Exposure benchmark

79 Employers need to be clear from the outset for which processes and sources the new LEV is required. They should also state a benchmark in the specification for LEV – the exposure that may result once the control is in place. This is likely to require expert advice. A suitable exposure benchmark would be a fraction of a substance’s exposure limit.

80 But many substances – including substances in mixtures – do not have exposure limits. One way forward is to use a variation of ‘COSHH essentials’ taking account of its technical basis (see *The technical basis for COSHH essentials*¹³). The scheme uses information that should be readily available on the substance or product. The steps you should take are in Appendix 2.

LEV and COSHH essentials

81 COSHH essentials¹⁴ is an online system for employers in small and medium-sized businesses which helps identify the level of control required for a task. It uses substance toxicity, dustiness or volatility, quantity and time for the task. It can inform but does not constrain the decisions of LEV suppliers and designers.

REACH

82 REACH is the European Union regulation concerning the Registration, Evaluation, Authorisation and restriction of Chemicals. A major part of REACH is the requirement for manufacturers or importers of substances to register them with a central European Chemicals Agency (EChA). A registration package will be supported by a standard set of data on that substance. The amount of data required is proportionate to the amount of substance manufactured or supplied.

83 Companies that use chemicals have a duty to use them in a safe way and information on risk management measures (RMMs), including LEV, should be passed down the supply chain.

84 Information exchange is a key feature of REACH. Users should be able to understand what manufacturers and importers know about the dangers involved in using chemicals and how to control these risks. However, chemical suppliers need information from the users about how they are used so that they can assess the risks. REACH provides a framework in which information can be passed both up and down supply chains.

85 REACH adopts and builds on the previous system for passing information – the safety data sheet. This should accompany materials through the supply chain, providing the information users need to ensure chemicals are managed safely. Safety data sheets will, in time, include information on safe handling and use. There is a duty on ‘downstream users’ (employers) to apply the risk management measures specified in the safety data sheets.

86 The HSE website explains more about REACH.⁶

Table 3 Applying LEV: Common design issues for the supplier

| Issue | Potential solution |
|--|---|
| Employer’s LEV requirement not clear | Employer to follow INDG408 <i>Clearing the air</i> |
| Contaminant cloud behaviour not known | Characterise the cloud – volume rate of release, volume, shape, speed, direction and contaminant concentration Identify all contaminant clouds, including partly visible clouds |
| Type of LEV | Follow risk management measures (REACH) Consider control approach (eg use COSHH essentials) Use enclosing, receiving or capturing hood, or a variant of these, capable of effective control |
| Design of hood, duct, air cleaner, air mover and safe discharge | See Chapters 6 and 7 |

| | |
|--|---|
| Have all the employer's requirements been addressed in the specification? | Identify processes and sources to be controlled Assess the required reduction of potential exposure Include system instrumentation, including suitable means of performance monitoring and control Include arrangements for training users Provide a user manual and logbook for the system |
|--|---|

Chapter 6 Hood design and application

Key points

- Successful LEV systems contain, capture or receive the contaminant cloud within the LEV hood and conduct it away.
- The greater the degree of enclosure of the source, the more likely it is that control will be successful.
- The value of monitoring the performance of the hood, eg by using an airflow indicator.

87 This chapter describes the selection of, and design principles for, LEV hoods.

Introduction

88 Hood selection and design are critical to the performance of an LEV system and must match the process, the source, production and how the operator carries out the process.

89 The employer should have assessed whether it is possible to eliminate the source or reduce its size. Compliance with COSHH requires this prior assessment before considering the application of LEV to processes. The contaminant cloud concentration, size or velocity may be too great for an LEV system to cope. It is therefore not always feasible or practical to apply LEV and other control measures may be necessary. The employer should examine other options such as segregation or enclosure. Examples of sources which are difficult to control using LEV include:

- very large sources; or
- many small sources; or
- moving sources.

90 The process and source factors (Chapter 4) should help the supplier and designer to:

- decide on the most effective type of LEV hood;
- maximise the enclosure of the source;
- maximise the separation between the contaminant-laden air and the operator's breathing zone;
- determine the size and shape of the hood;
- specify the hood airflow minimum face velocity that will be required.

91 LEV design and application requires a good understanding of:

- how the contaminant cloud moves away from the sources;
- the cloud size, speed and direction;
- the airflow induced by LEV and its effect on the contaminant cloud and other processes;
- the influence of the hood size and shape on cloud capture and containment;
- the effect of workroom air movement on the LEV;
- the position of employees (process operators) and the flow of contaminated air into their breathing zones.

92 If there is a need for a process change to make the proposed LEV effective, the supplier must tell the employer and together they need to review the process requirements and contaminant cloud sources. Any changes must be practical and control exposure effectively. See Figure 8.

93 Certain industries have 'standard designs' of LEV for 'standard' processes. However, some of these are ineffective. For example, some bench-mounted fan and filter units that are commonly used for solder fume control. Designers and suppliers should ensure the proposed system will be effective and provide adequate control.

Choosing the right type of hood

94 LEV systems work effectively when the airborne contaminant cloud is contained, received or captured by the hood. The effectiveness of LEV can be judged by:

- how much the hood constrains the contaminant cloud;
- how well the LEV-induced airflow carries the contaminant cloud into the system;
- how little of the contaminant cloud enters the process operator's breathing zone.

Classification of LEV hoods

95 Hoods have a wide range of shapes, sizes and designs. While they may look similar, they control contaminant clouds in three different ways. The 'classification' of hoods highlights their essential features and they fall into three basic categories:

- enclosing hoods;
- receiving hoods;
- capturing hoods.

96 This classification applies in most circumstances. Sometimes hoods work in 'mixed-mode'. Only when an LEV hood does not fit the classification should the supplier/designer consider design from first principles.

Enclosing hood

97 Enclosures are always more effective than capturing or receiving hoods. A full enclosure is where the process is completely enclosed, eg a glove box. A room enclosure or enclosing room is where the operator and the process are enclosed, eg abrasive-blasting rooms or paint-spraying cabins. They may also be called laminar flow rooms or booths. A partial enclosure contains the process with openings for material and/or operator access, eg walk-in booths and fume cupboards.

Receiving hood

98 The process usually takes place outside the hood. The hood receives the contaminant cloud, which has a speed and direction that is usually process-generated. Hoods can be fixed or moveable. A canopy hood over a hot process is a classic receiving hood. A push-pull system is a special type of receiving hood.

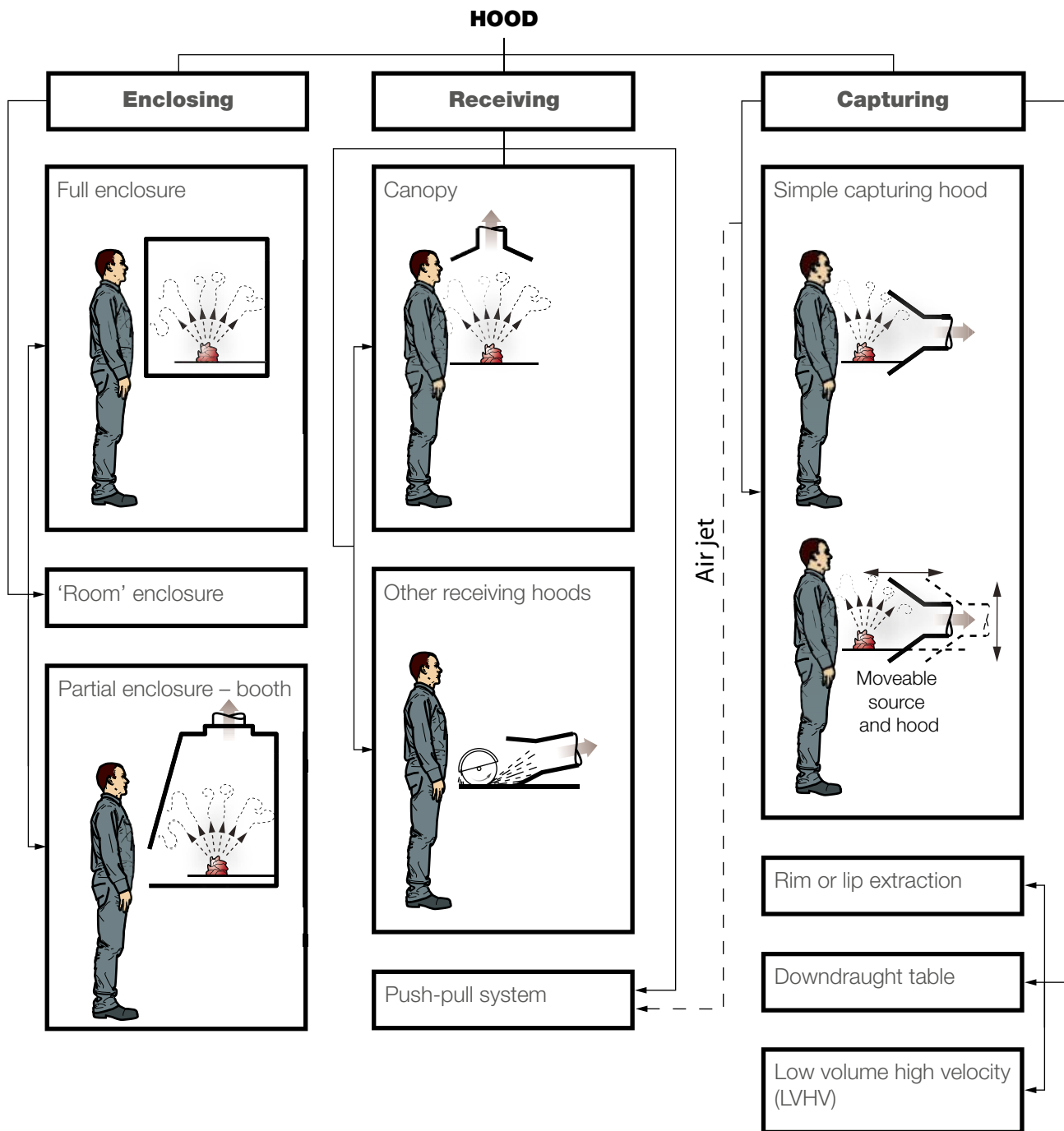

Figure 10 Classification: Types of LEV hood

Capturing hood

99 This is the most common type of LEV hood and is sometimes called a captor or capture hood. The process, source and contaminant cloud are outside the hood. A capturing hood has to generate sufficient airflow at and around the source to 'capture' and draw in the contaminant-laden air. They all work on the same broad principles, but can range in size from a few millimetres for on-tool extraction to metres long in large industrial processes. Hoods can be fixed or moveable. They include rim/lip extraction (slot), dowlndraught tables or benches and Low Volume High Velocity (LVHV) hoods.



Figure 11 Enclosing hood

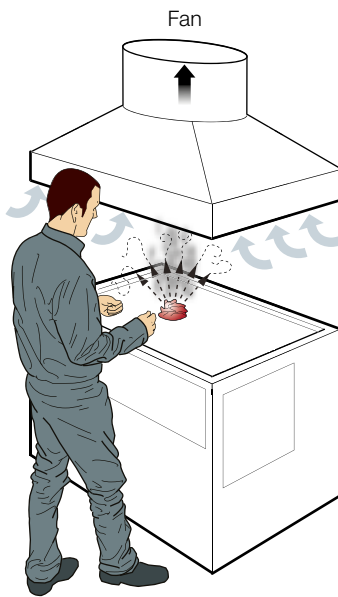

Figure 12 Receiving hood

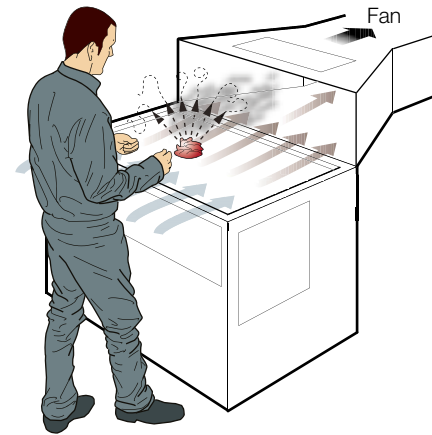

Figure 13 Capturing hood

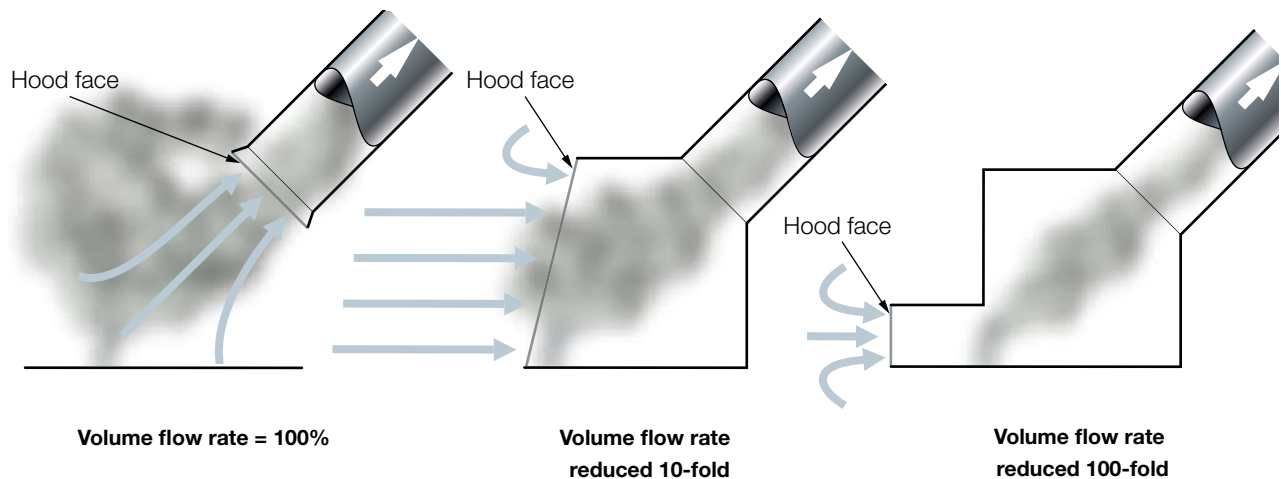

Figure 14 Maximise enclosure for effectiveness and efficiency

General principles of LEV hood design and application

100 The general principles of LEV hood design and application are:

- Maximise the enclosure of the process and source, because the greater the degree of enclosure, the more likely it is that the LEV will be effective.
- For capturing and receiving hoods, make sure the hood is as close as possible to the process and source.
- Position the hood to take advantage of the speed and direction of the airflow from the source.
- Match the hood size to the process and contaminant cloud size.
- Separate the contaminant cloud from the worker's breathing zone as much as possible.
- Minimise eddies within the hood.
- Use ergonomic principles when designing the application of an LEV hood and make sure it is consistent with the way the worker actually does the job.

- Try out the LEV selected; make prototypes and get feedback from users.
- Use observation, information on good control practice and simple methods, eg smoke or a dust lamp, to assess exposure control effectiveness. Take measurements, eg air sampling, where necessary.
- Match the LEV control effectiveness to the potential degree of overexposure based on:
 - how exposure occurs;
 - the capabilities of different hood types and designs.

101 For an individual process, increasing the degree of enclosure:

- improves the efficiency of the extraction;
- reduces the volume flow rate required to achieve the specified degree of control;
- reduces the running costs.

Control effectiveness

102 The efficiency and effectiveness of an LEV hood can be reduced by flow separation, recirculatory eddies and air turbulence.

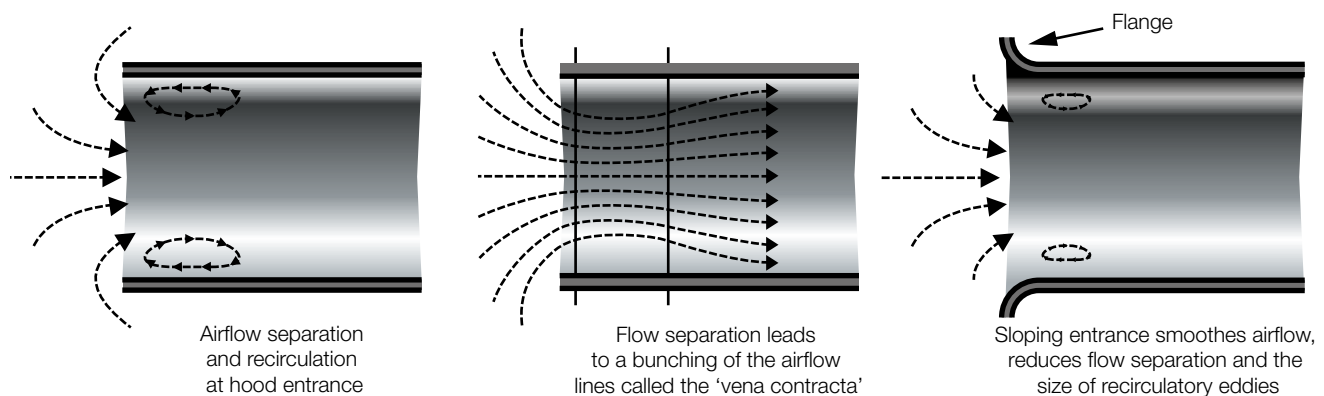

Figure 15 Airflow into a hood

Flow separation, eddies and turbulence

103 Where flowing air enters a hood there is always some 'flow separation' creating recirculatory or rolling eddies just inside the hood entrance, and air turbulence within the hood (see Figure 15). Airflow streamlines become bunched-up in a region called the *vena contracta*. In larger LEV hoods, such as partial enclosures, the rolling eddies can protrude from the hood face and cause airborne contaminant leakage. As a general rule the greater the flow separation, and the more pronounced the *vena contracta*, the lower the hood efficiency. Also, for the larger LEV hood, the greater the flow separation the larger the rolling eddies, which decrease hood control effectiveness.

Draughts

104 Draughts can reduce the effectiveness of hoods and have many causes, including:

- turbulence from other processes nearby;
- the natural effects of windy weather;
- cooling fans;
- open doors and windows;

- vehicle movements;
- workers moving around nearby;
- poorly planned make-up air.

105 To capture, contain or receive airborne contaminant clouds, a minimum face velocity must be provided at each LEV hood. An LEV hood, especially the larger designs such as partial enclosures, should also have a minimum face velocity to resist the effects of workroom draughts and general air turbulence. The minimum required will vary depending on the circumstances. If draughts cannot be suppressed or mitigated, a higher face velocity will be needed to minimise hood leakage. Any of the larger types of hood should also be deep enough to reduce the spillage of contaminated air released inside, or directed into, the hood. Draughts can be assessed by observation, visualisation with smoke tracer and velocity measurement.

Airflow indicators

106 Employers should make sure that LEV systems continue to work properly. There are several ways of checking this, such as using an anemometer, dust lamp or smoke tracer – with the work process running. The simplest way is probably to use an airflow indicator. This will give the operator a simple indication that the hood is working properly. It becomes critical when the operator has to adjust a damper to get adequate airflow. The airflow indicator must indicate simply and clearly when the airflow is adequate. The simplest indicator is usually a manometer. (Also see ‘LEV instrumentation’ in Chapter 7.)

107 The rest of this chapter examines the types of hood in more detail. A set of design principles follows the description of each type of hood.

Enclosing hoods

Full enclosures

108 In full enclosures, the process and the source are within the hood, however large. Examples of full enclosures include glove box, isolator or reactor. Total enclosure does not necessarily mean complete isolation – there will need to be provision, for example, to allow replacement air to be drawn in, for materials handling, sampling, or filter changes.

109 The enclosure acts as a ‘holding volume’. Good design ensures that disturbances in pressure caused by the process cannot lead to spillage of contaminant out of the hood. The pressure inside the enclosure must always be lower than that in the workroom outside the enclosure. The enclosure should be large enough to maintain negative pressure and contain any sudden release of contaminant. The design principles are in Table 4.

‘Room’ enclosures

110 Room enclosures contain the operator and the process and are totally enclosed. They are frequently referred to as booths, rooms or cabins and may be named to describe the process which takes place inside them, eg abrasive-blasting booth, paint-spraying cabin, isolation room, or clean room. Such enclosures are available commercially. The main objectives of these enclosures are to:

- contain the contaminant cloud to prevent other employees being exposed;
- reduce the process operator’s (the employee’s) exposure;
- discharge cleaned air to atmosphere.

Table 4 Full enclosure: Design principles

| | |
|------------------|---|
| Enclosure | Predict the maximum source size and make the enclosure large enough for the contaminant cloud |
| | Make the enclosure large enough to maintain negative pressure and contain any sudden release of contaminant |
| | Minimise the impact on walls and ensure the cloud is directed away from openings and entrance ports |
| | Minimise gaps in the fabric of the enclosure |
| | Make hinges, seals and fixings robust |
| | Plan the inlet port and filter sizes |
| | Provide an alarm in case of overpressure |
| Airflow | Select an extraction flow rate to exceed the maximum volume flow rate from the source. The pressure differential should be large enough to draw replacement air through gaps in the enclosure body or through entry filters, and minimise leakage of contaminated air |
| Usability | Design for long-term working by operators of different sizes |
| | Should be comfortable and usable, eg with lighting inside (or from outside) the enclosure and transparent inspection panels |
| | Locate process instrumentation outside the enclosure |
| | Provide visible monitoring instrument displays and accessible controls |
| | Liaise with supervisors and process operators |
| | Design for a clearance time, after which interlocks on the enclosure will release |

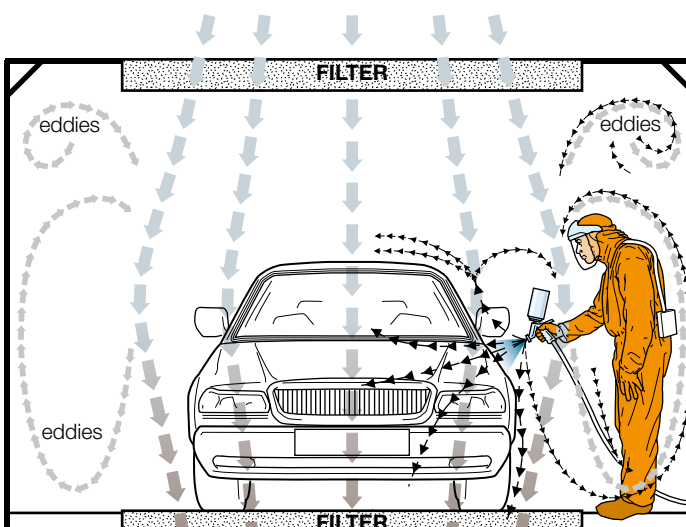

Figure 16 Spray booth or room enclosure

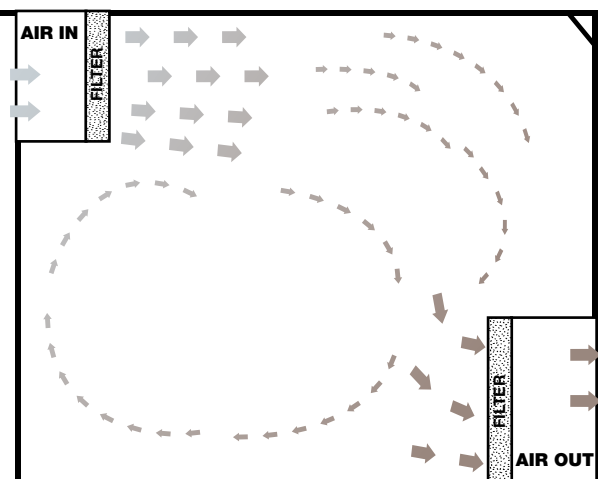

Figure 17 Cross-flow room

111 Ventilation may be:

- downward (downdraught or vertical airflow), where clean air enters through a filter that covers, or nearly covers, the ceiling. It exhausts through the floor, eg Figure 16; or
- cross-flow (cross-draught or horizontal airflow), where clean air enters through filters that partly cover a wall. It exhausts through filters in an opposite wall or the floor, eg Figure 17; or
- hybrids of these.

112 Effective designs maximise 'piston' or one-way smooth airflow. However, this objective is not often achieved.

113 The inward and outward airflows should balance to produce a slightly lower pressure than that outside the room. In most rooms, the airflows induce large-scale eddies.

Clearance time

114 The clearance time of room enclosures is frequently overlooked. A considerable time may elapse between shutting off the source and the air in the room being fit to breathe. The more persistent the eddies, the more they will retain the contaminant and the longer the clearance time. The exposures of process operators are greater when clearance times are long. To avoid the problem:

- the designer should minimise the clearance time;
- airflow within the room should not stop until the clearance time has elapsed;
- people using enclosing rooms should know how to get in and out safely. The room may need an entrance vestibule;
- the 'LEV commissioner' should establish or confirm the clearance time. The time must be displayed and everyone concerned should be told.

115 Workers in room enclosures often need effective respiratory protection. Where necessary, the designer should make provision for constant airline flow breathing apparatus as respiratory protective equipment (RPE). The design principles for room enclosures are in Table 5.

Partial enclosures (booths)

116 Partial enclosure is a compromise between containment and accessibility. The advantages over capturing hoods are:

- more effective exposure control;
- the physical enclosure of the walls and roof can reduce the volume rate needed for effective control;
- the source is shielded from draughts;
- the source (and sometimes the complete process) is within the hood and capture is not required;
- the airflow dilutes and displaces the contaminant cloud.

117 Although partial enclosures can control exposure more effectively than capturing hoods, they may require relatively large volumes of air. Replacement or make-up air needs careful planning (see Chapter 7).

Table 5 Room enclosure: Design principles

| | |
|------------------|---|
| Enclosure | <p>Maintain at negative pressure to ensure inward air leakage</p> <p>Design for the specific process using suitably robust materials, eg hinges, seals and fixings for optimum containment</p> <p>Plan air input, output and flow within the room to minimise eddies and clearance time</p> <p>Disrupt large-scale eddies, eg with air jets</p> <p>Design to run ventilation until clearance time has lapsed (purge time)</p> <p>Provide an alarm in case of pressure in the enclosure exceeding the pressure outside (overpressure)</p> <p>Where practicable, fit an interlock to halt the process, eg spraying, in case of overpressure</p> |
| Airflow | <p>Design for smooth airflows in and out and anticipate declines in performance, eg outlet filter blockage</p> <p>Design to an airflow volume specification</p> <p>Take into account typical obstructions for normal use</p> |
| Usability | <p>Design for use by operators wearing RPE</p> <p>Provide a plug-in point where constant flow airline breathing apparatus is needed</p> <p>Include a visible instrument display of room pressure and audible alarms. As a minimum, include a manometer showing room internal pressure</p> <p>Locate instrumentation outside the enclosure</p> <p>Design the enclosure and work methods based on good ergonomic principles and safe use, eg access, work at height, materials handling</p> <p>Provide viewing panels and lighting inside the enclosure</p> <p>Clearly indicate room clearance time and explain the importance and relevance of clearance time to operators and supervisors</p> |

Large booths

118 Some partial enclosures are sufficiently large to work in and are usually known as 'walk-in' booths. There is no physical barrier between the source and the operator. They can be very effective but, in some cases, the operator may work in contaminated air and supplementary RPE may be necessary.

Small booths

119 Other partial enclosures are smaller. The operator outside the booth may be at arm's length from the source, sometimes with a barrier between the source and the breathing zone. A fume cupboard is a partial enclosure.

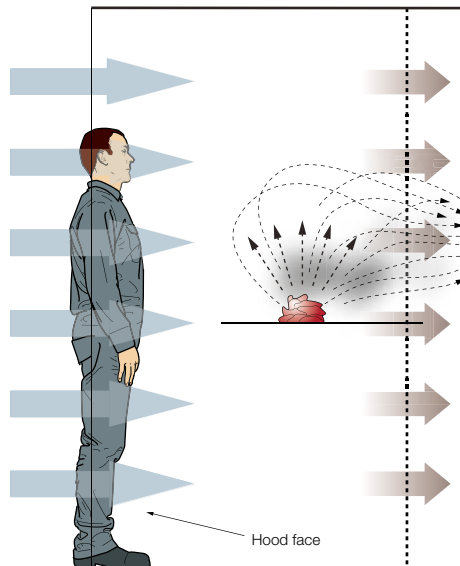

Figure 18 Large booth

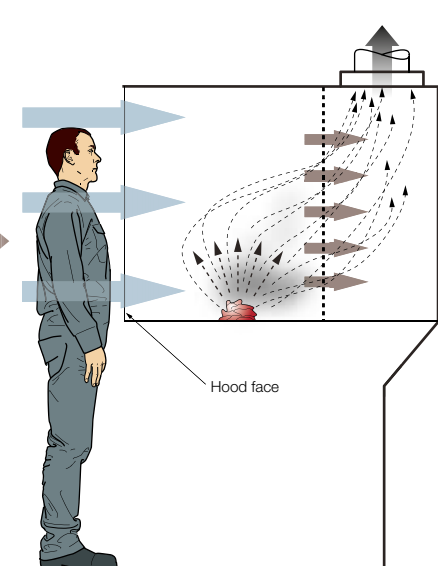

Figure 19 Small booth

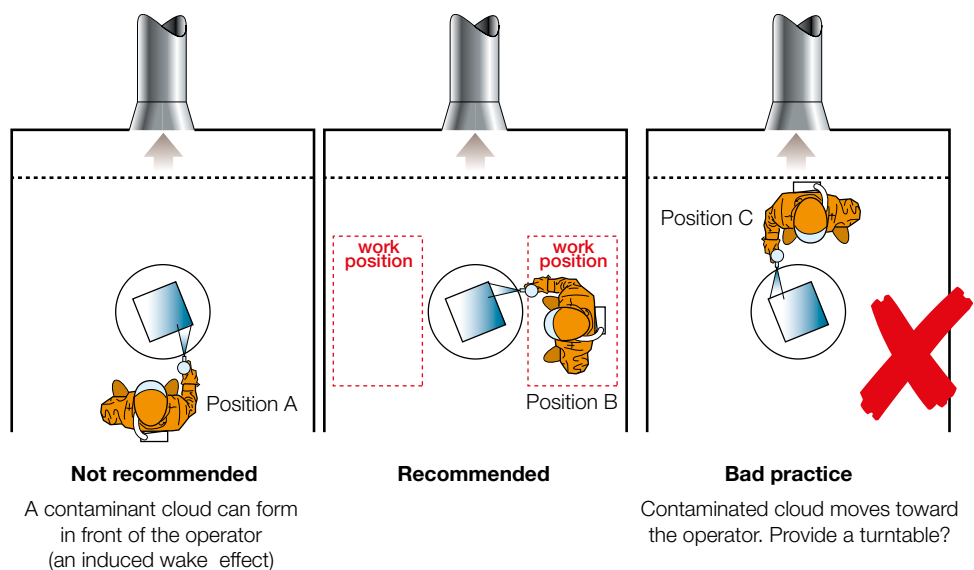

Figure 20 Work positions in a 'walk-in' booth

Booths: Usability and work position

120 Partial enclosures retain the contaminant cloud by inward airflow through the enclosure's open face, drawing the cloud towards the hood extraction point. Where the source or process produces a contaminant cloud which moves in a defined direction at high speeds:

- the enclosure should have a jig or turntable to limit the potential for the operator to direct the contaminant cloud out of the partial enclosure;
- the correct working positions should be indicated.

121 The designer needs full information about the process to specify:

- the partial enclosure size;
- the size and shape of openings for access or use;
- process arrangements for movement of components or materials, eg crane hoists, conveyors, cleaning arrangements.

Wake effect in partial enclosures

122 The presence of an operator at the open face of a partial enclosure creates an obstruction to the airflow. This obstruction creates a region of turbulent slow-moving air in front of the operator called the 'wake'.

123 Contaminant cloud trapped in the wake may flow into the breathing zone before being drawn into the hood. How much this happens depends on the size of the hood opening, the airflow rate, the position of the operator and the source. The wake effect has most impact where the booth is small, the operator works at the face and is close to the contaminant source (see Figure 23). In this case, flow separation and recirculation at the hood entrance may contribute to bringing contaminated air back into the wake and into the operator's breathing zone. This effect can be reduced by moving the source further into the enclosure, away from the operator (see Figure 24).

124 Other solutions to reducing the impact of the wake effect are illustrated in Figures 25 and 26. The design principles for partial enclosures are in Table 6.

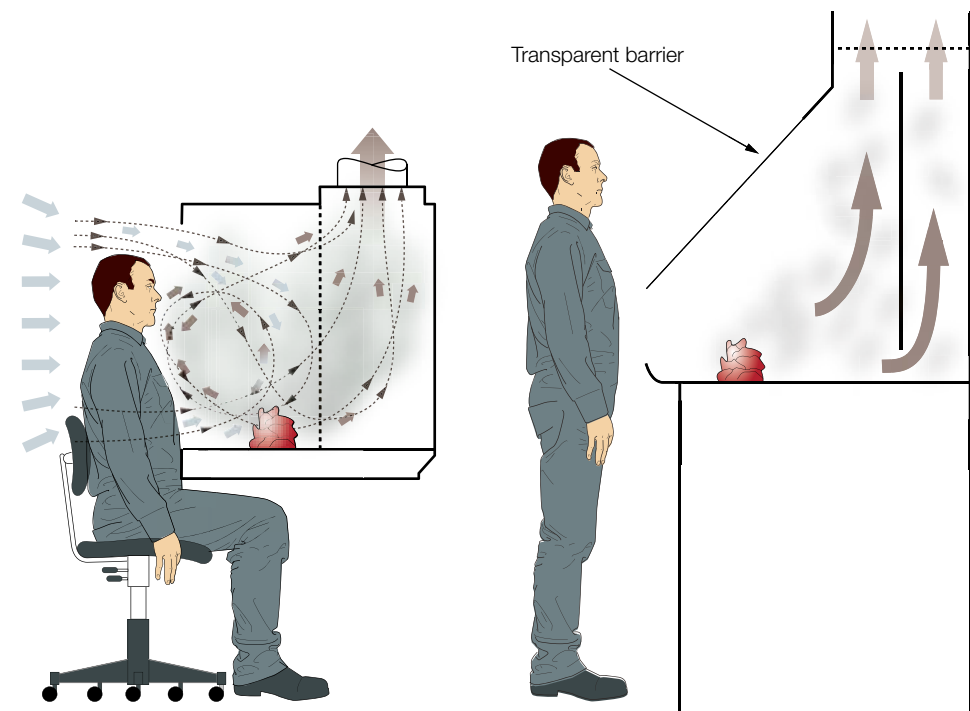

If the booth is too shallow, hot contaminant clouds can escape due to eddies and wake effects

Figure 21 Partial enclosing hood showing wake in front of worker's body

Figure 22 Open-fronted booth with transparent barrier

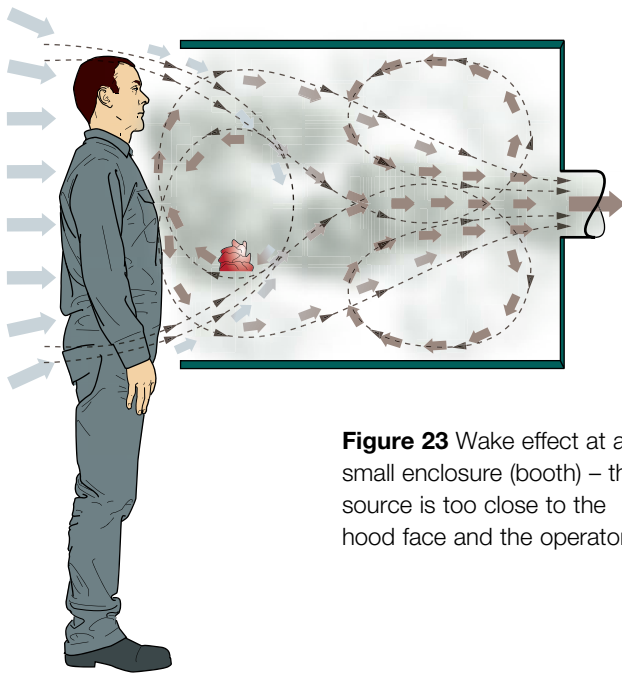

Figure 23 Wake effect at a small enclosure (booth) – the source is too close to the hood face and the operator

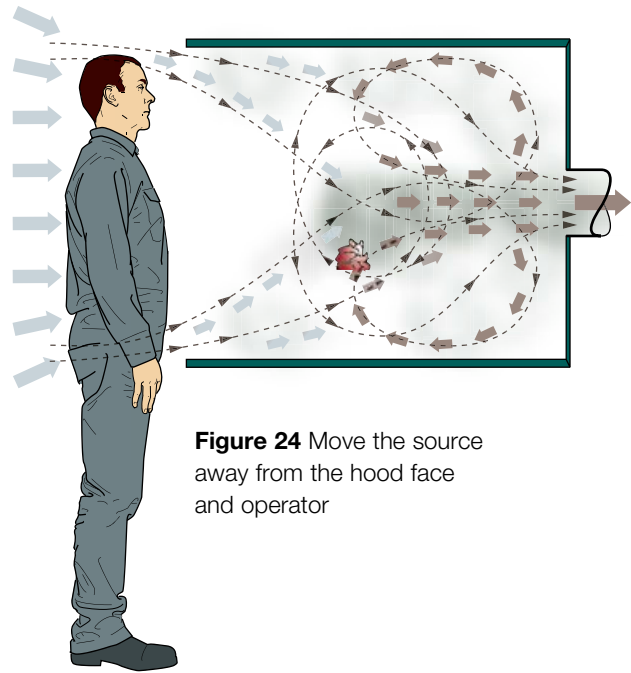
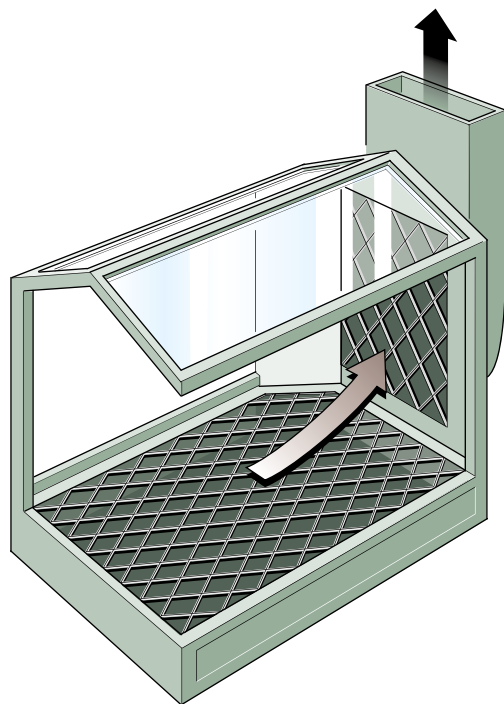

Figure 24 Move the source away from the hood face and operator



This physically separates the breathing zone and the source, and the side-draught minimises the creation of the wake in front of the operator

Figure 25 Reducing wake effect using a side-draught hood

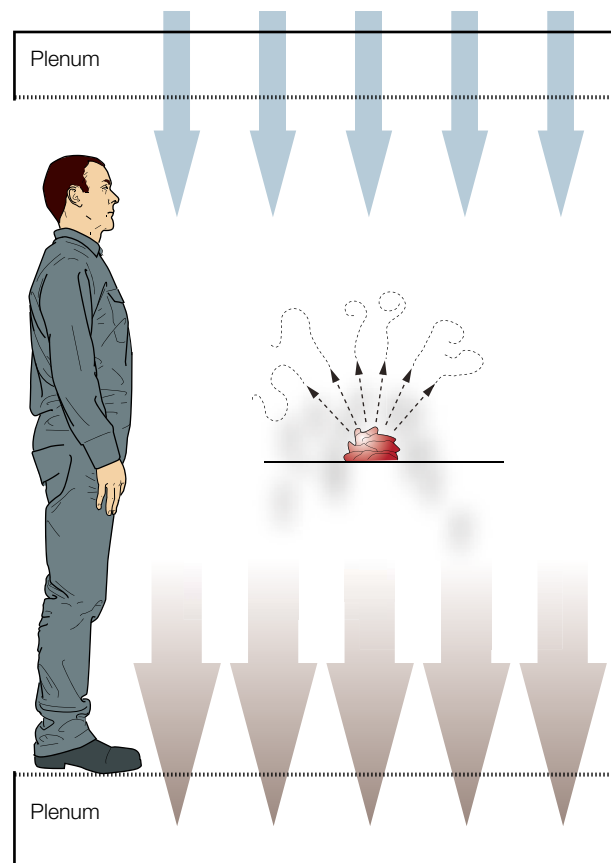

Figure 26 Reducing wake effect using a downdraught walk-in booth

Receiving hoods

125 All receiving hoods work on the same principles.

- The process takes place outside the hood.
- The contaminant cloud is propelled into it by process-induced air movement.
- The hood, especially the face, must be big enough to receive the contaminant cloud.
- The extraction empties the hood of contaminated air at least as fast as it is filled.

Canopy hood

126 A common form of receiving hood is the canopy hood placed over a hot process to receive the plume of contaminant-laden air given off. It is important to separate the rising plume from the operator's breathing zone. For cold processes with no thermal uplift, canopy hoods are ineffective. Canopy hoods do not protect the operator who needs to work above a hot process (see Figure 27).

Canopy hood design and application

127 The hood receives the expanding cloud. It should be placed as close as possible to the process to intercept the cloud before it grows through mixing. This also reduces the cloud's susceptibility to draughts, as does partial enclosure at the sides and back.

128 As a design rule of thumb, the extract rate should be 1.2 times the volume flow rate of the rising plume at the face of the hood. The overlap over the source area should be 0.4 times the height above the source.¹⁵

Other receiving hoods

129 A receiving hood can be applied wherever a process produces a contaminant cloud with a strong and predictable direction. For example, a grinding wheel, like all rotating discs, acts as a crude fan. The guard acts as a fan casing and directs the air jet mainly in the direction of the wheel rotation (see Figure 28). The receiving hood must be large enough and close enough to intercept the contaminant cloud (invisible) and the jet of fast-moving large particles (visible). The design principles for receiving hoods are in Table 7.

Table 6 Partial enclosure: Design principles

| | |
|------------------|---|
| Enclosure | <p>Characterise the source – its size, the contaminant cloud volume flow rate and its velocity</p> <p>Make the enclosure large and deep enough to contain the source and the contaminant cloud</p> <p>Design to minimise operator exposure</p> <p>Design the hood entrance to create an even flow of air</p> <p>Eliminate the wake effect, eg use downdraught, side-draught or work sideways-on to the airflow</p> <p>Mitigate the wake effect, eg place the source further away from the operator, place a transparent barrier between the source and the operator's breathing zone or use local air displacement</p> <p>Minimise obstructions inside the hood, especially near the entrance</p> <p>Locate to minimise the influence of external draughts</p> <p>Minimise the hood face open area with adjustable openings to the hood where feasible, eg a fume cupboard sash</p> |
| Airflow | <p>Design the face velocity to be sufficient to contain the contaminant cloud, ie a minimum of 0.4 m/s unless a lower face velocity is shown to be effective</p> <p>Choose a volume flow rate able to clear the hood of the realistic worst-case volume flow rate of contaminant cloud</p> <p>Locate the process and workstation to direct the contaminant cloud into the hood</p> <p>Design the enclosure to create even airflow at the face and within the hood</p> <p>Anticipate any fall in performance, eg from a filter blockage</p> <p>Design to minimise eddy formation</p> |
| Usability | <p>Design the enclosure and work methods based on good ergonomic principles, eg for access and materials handling</p> <p>Study methods of working and redesign in liaison with the operator and supervisor. Prepare prototype designs</p> <p>Recommend jigs and tools that help the task</p> <p>Provide a display of adequate airflow, eg a manometer, on the hood duct to measure and display static pressure</p> <p>Design for use of RPE if operators require it</p> <p>Provide lighting inside the enclosure</p> |

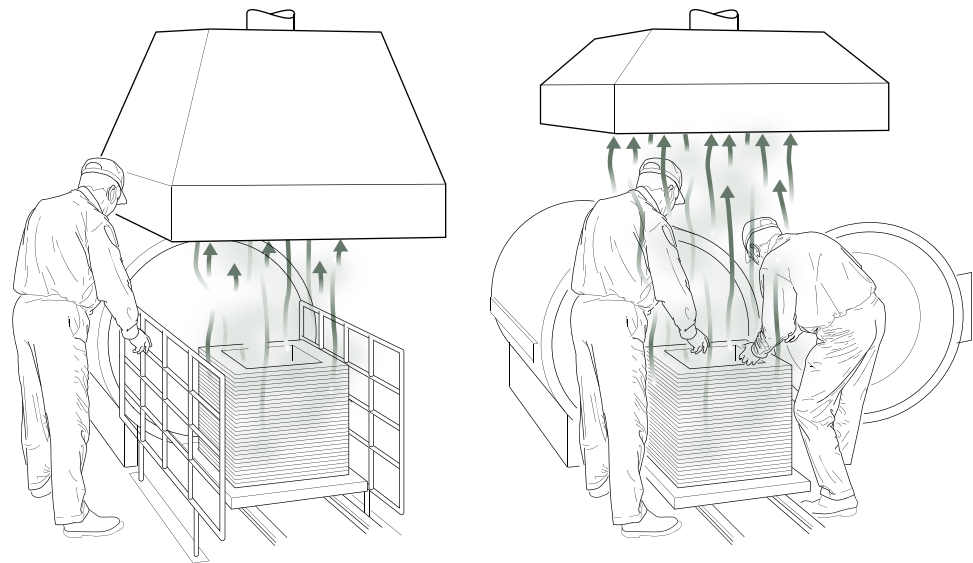

Good control design – operator kept away from fume

Poor control design – the operators are not kept away from fume

Figure 27 Canopy hoods over a hot process

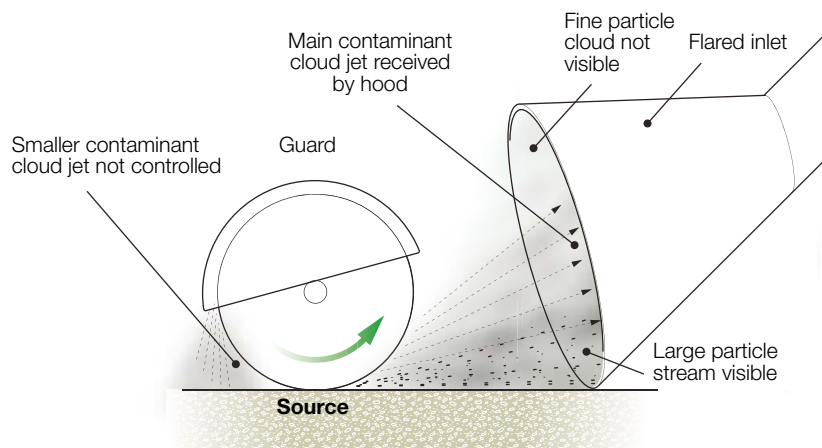
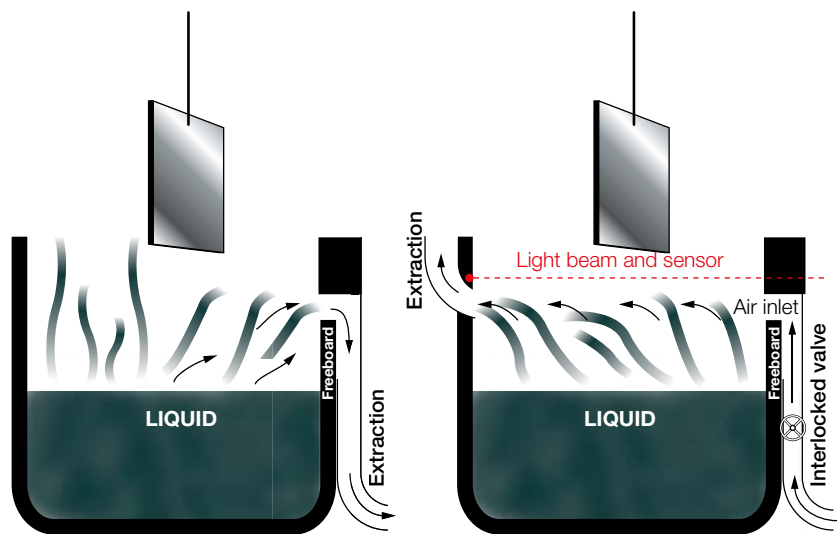

Figure 28 Grinding wheel and receiving hood



The tank is too wide for capture slots to be effective (left) while push-pull ventilation can be effective (right). Air blows from the slot across the tank towards the receiving hood, carrying and entraining the contaminant cloud

Figure 29 Push-pull applied to an open-surface tank

Table 7 Receiving hood: Design principles

| | |
|------------------|---|
| Location | <p>Design the process layout so that the contaminant cloud flows towards the hood</p> <p>Avoid or suppress draughts, especially for hot, relatively slow-moving, plumes</p> <p>Place the hood as close to the source as possible</p> <p>Can the hood be incorporated in machinery guarding, eg a partial enclosure?</p> |
| Hood | <p>Provide a hood with a large enough area and shape to hold the maximum volume flow of contaminated cloud</p> <p>Assess the variation and realistic worst-case volume flow rate of the whole contaminant cloud, not just that visible in normal lighting. Make it visible, eg with a Tyndall beam or smoke</p> <p>Receiving hoods are inappropriate controls for sources with little or no directional air movement or thermal lift</p> <p>Select a different LEV hood design, eg a partial enclosure, if operators are exposed to the contaminant cloud, or design the workstation for the use of supplementary RPE</p> |
| Airflow | <p>Design the volume flow rate to empty the hood at least as fast as it fills, to contain and remove the worst-case contaminant clouds</p> |
| Usability | <p>Provide an airflow indicator, eg a manometer, on the hood duct to measure and display static pressure</p> <p>Design the hood and work methods based on good ergonomic principles</p> <p>Liaise with process operators and supervisors</p> |

Push-pull system

130 Push-pull ventilation uses an air jet to blow contaminant-laden air that has little or no velocity towards an extraction hood. It converts a capturing hood into a receiving hood. Push-pull systems are inappropriate where, for example, draughts or process components can divert the push jet. The design principles are in Table 8. Push-pull systems are appropriate when:

- enclosures or an overhead canopy would block access or interfere with the process;
- an operator needs to work over a process emitting a contaminant cloud;
- a tank is too large for capture slots to control vapour or mist contaminant clouds.

131 The receiving hood should be designed so that it:

- is large enough to intercept the whole of the contaminant cloud;
- is located in line with the push jet;
- has a volume flow sufficient to empty the receiving hood at least as fast as it is filled.

132 For example, a push-pull system may be the right control solution for an open surface tank. They also have uses for large area, low energy sources such as laminating glass-reinforced plastic with styrene-containing resins.

133 For large articles lowered into and raised from the tank, the designer should provide:

- an interlock to turn off the inlet air jet when a workpiece is raised or lowered. Otherwise, the jet of contaminated air is diverted by the workpiece into the workroom;
- means to control vapour from articles that may be wet with solvent, eg a tank freeboard or drying hood.

Table 8 Push-pull systems: Design principles

| | |
|-----------------------|--|
| Location | <p>Design the work process and the blowing jet so that the contaminant cloud flows predictably towards the receiving hood</p> <p>Avoid or suppress draughts</p> <p>Consider vapour controls for drying articles (tank dipping)</p> |
| Inlet jet | <p>Design to deliver air/contaminant jet exactly to the receiving hood</p> <p>Experiment and use smoke or other means to check on the size, direction and flow rate of the 'push' jet</p> <p>Provide interlocks to turn off the jet where an object obstructs the receiving hood</p> |
| Receiving hood | <p>Place as close to the source and jet as possible and make sure it is large enough to receive the contaminant cloud jet</p> <p>Maximise the source enclosure</p> |
| Airflow | <p>Design to empty the hood at least as fast as it fills</p> <p>The extracted volume flow rate must exceed the inlet air jet volume flow rate</p> |
| Usability | <p>Provide an airflow indicator, eg a manometer, on the jet air supply to indicate appropriate airflow and a manometer on the hood duct to measure and display static pressure</p> |

Capturing hood

134 The process, source and contaminant cloud are outside the capturing hood. This has to generate sufficient airflow at and around the source to 'reach out', 'capture' and draw in the contaminant-laden air. Capturing hoods are also known as exterior, external or captor hoods; they have a number of common names including slot and ventilated bench. The design principles are in Table 10. A capturing hood may be appropriate when the process cannot be enclosed or the contaminant cloud has no strong **and** reliable speed and direction.

135 Capturing hoods may be:

- flanged or without a flange, or with a flared inlet;
- freely suspended, or resting on a surface;
- fixed, moveable or attached to mobile extraction units;
- small or large in size from a few millimetres to over half a metre in diameter and up to several metres long;
- applied to a process or built into equipment such as a hand-held tool.

136 Capturing hoods are widely used because:

- they may be easy to retro-fit;
- they often interfere less with the process;
- there are many suppliers of off-the-shelf systems.

137 For the great majority of sources requiring control, however, a capturing hood is much less effective than the designer intended because:

- the capture zone is often too small;
- the capture zone can be disrupted by draughts;
- the capture zone does not encompass the working zone;
- the nature of the task moves the working zone out of the capture zone;
- the capture efficiency is over-estimated;
- there is a lack of information about the capture zone size.

138 All of these drawbacks have design solutions, but the optimum solution may be to choose or develop another type of LEV hood with a greater degree of enclosure. The key characteristics of 'capture' should be fully understood both by the LEV supplier and the employer (see Figure 31).

Capture velocity

139 'Capture velocity' is the velocity required at a contaminant source to overcome the movement of the contaminant cloud and draw it into the hood. But this is meaningful only with a defined distance between the source and the hood. Fast-moving contaminant clouds are very difficult to control with a capturing hood. They normally require a partial enclosure or receiving hood. The capture velocities quoted in Table 9 are based on success through experience. In practice, the designer and supplier should check and, where necessary, make prototypes.

140 The lower end of the range of capture velocities in Table 9 applies to:

- low toxicity, COSHH essentials Band A materials;
- low usage;
- intermittent uses;
- larger hoods;
- some directional airflow towards hood;
- no draughts.

141 The upper end of the range of capture velocities in Table 9 applies to:

- highly toxic, COSHH essentials Band D materials;
- high usage;
- continuous uses;
- smaller hoods;
- airflows away from the hood;
- draughts.

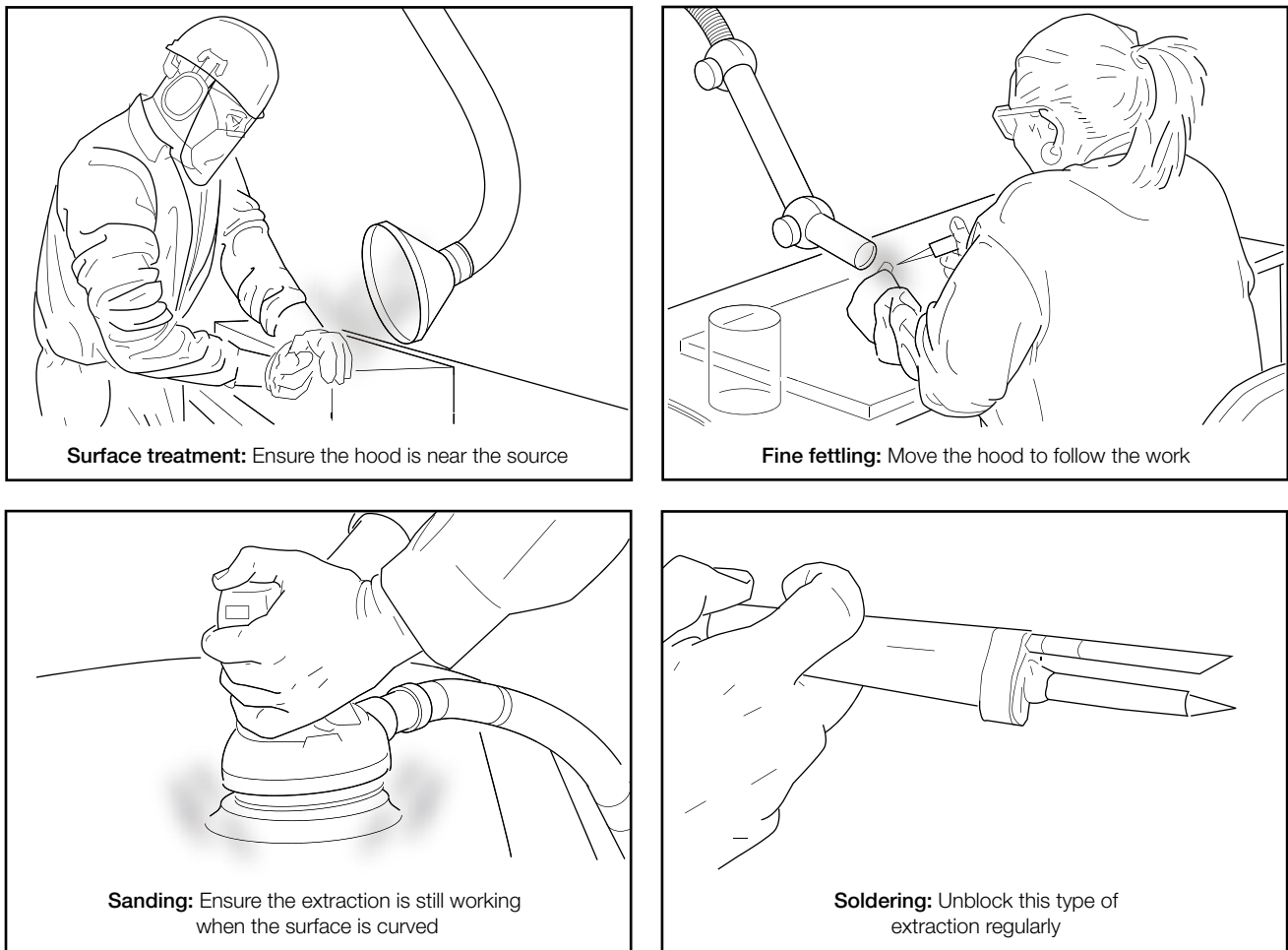

Figure 30 Some capturing hoods

Table 9 Capture velocities

| Contaminant cloud release | Example of process | Capture velocity range, m/s |
|---|---|-----------------------------|
| Into still air with little or no energy | Evaporation, mist from electroplating tanks | 0.25 to 0.5 |
| Into fairly still air with low energy | Welding, soldering, liquid transfer | 0.5 to 1.0 |
| Into moving air with moderate energy | Crushing, spraying | 1.0 to 2.5 |
| Into turbulent air with high energy* | Cutting, abrasive blasting, grinding | 2.5 to >10 |

*These types of cloud are difficult to control using capturing hoods.

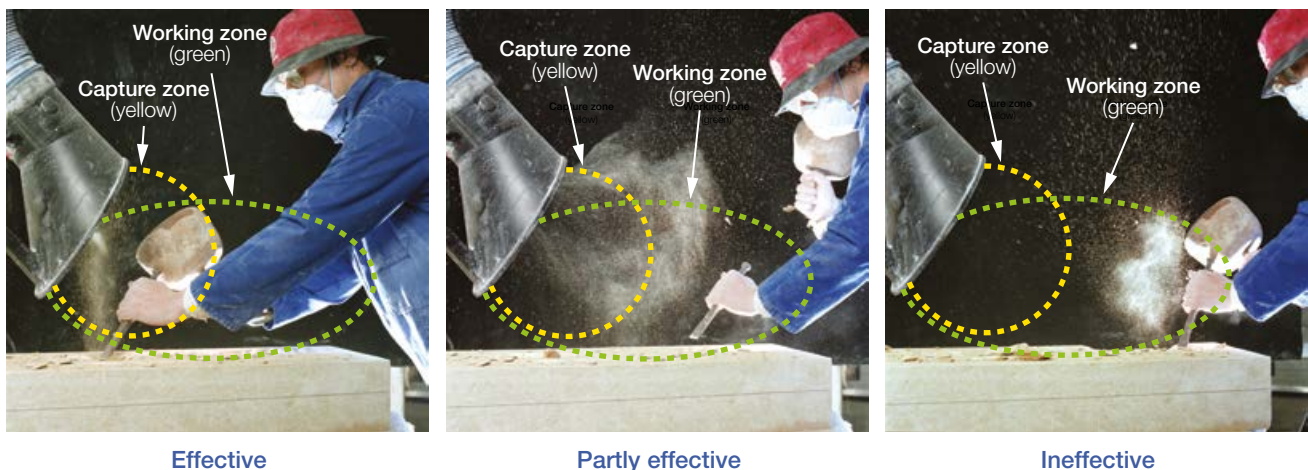

Figure 31 Capture zone and working zone

Capture zone, working zone and breathing zone

142 The capture zone of a capturing hood is the space in front of the hood where the air velocity is sufficient to capture the contaminant cloud. One way to envisage the capture zone is a 'bubble' in front of the hood. This 'bubble' is easy to disrupt – it can shrink and change shape. Draughts can severely affect the size and shape of capture zones, and powerful draughts virtually destroy them. Figure 31 shows a working zone within, partially within, and outside a hood's capture zone.

143 The capture zone is almost always smaller than the user expects. That is because the air velocity falls very rapidly in front of a capturing hood. As a rule of thumb, the air velocity will fall to about one-tenth of the face velocity at one hood diameter out from the face of a capturing hood.

144 The working zone is the space where the activity generates the contaminant cloud. For effective exposure control, the working zone must lie within the capture zone of a capturing hood.

145 The breathing zone is the region around operators from which they draw air for breathing (commonly defined as being within 300 mm of the nose or mouth).

Distance from the source

146 Capturing hoods are usually only effective when the source is within two hood diameters from the hood face. Further than this and it is likely that the hood will be ineffective. The shape of the capture zone depends on the hood's shape. The effective capture zone is severely limited, particularly for small hoods.

147 Measurements show that the degree of effectiveness of a capturing hood decreases sharply as the distance from the hood increases. All capturing hoods show this capture pattern. The smaller the hood, the smaller the 'partly effective' region. In practice, capturing hoods either capture or they don't; the difference between these two states is a small change in the work position. It is common to find that capturing hoods do not capture contaminant effectively – sometimes, they do not capture contaminant at all.

148 Process operators should know the size and shape of the capture zone so they can work within it. Suppliers and designers of capturing hoods need to provide information on the capture zone of their hoods in a practical way, for example:

- clearly mark out the capture zone on the workstation; or
- mark the hood with the maximum capture distance.

Moveable working zone

149 Some work processes are 'linear', in that the activity and source move along a workpiece or component, eg applying adhesive, seam welding. When applying capturing hoods to such activities keep the working zone within the capture zone, by using an adjustable hood or an adjustable workstation. Where this is impracticable, another type of hood or control should be used.

Capturing hood flanges

150 The airflow contours for a capturing hood extend around the back of the hood. With the source at the front of the hood, such airflow is 'wasted' – it has no effect on control. Flanges on capturing hoods:

- restrict the movement of air from behind a capturing hood;
- create a larger capture zone and a longer 'reach' in front of the hood;
- improve the air velocity distribution – the flow into the hood is smoother, with less eddying and this increases the hood 'entry coefficient', making it more efficient.

151 Figure 32 shows this effect with a square section capturing hood.

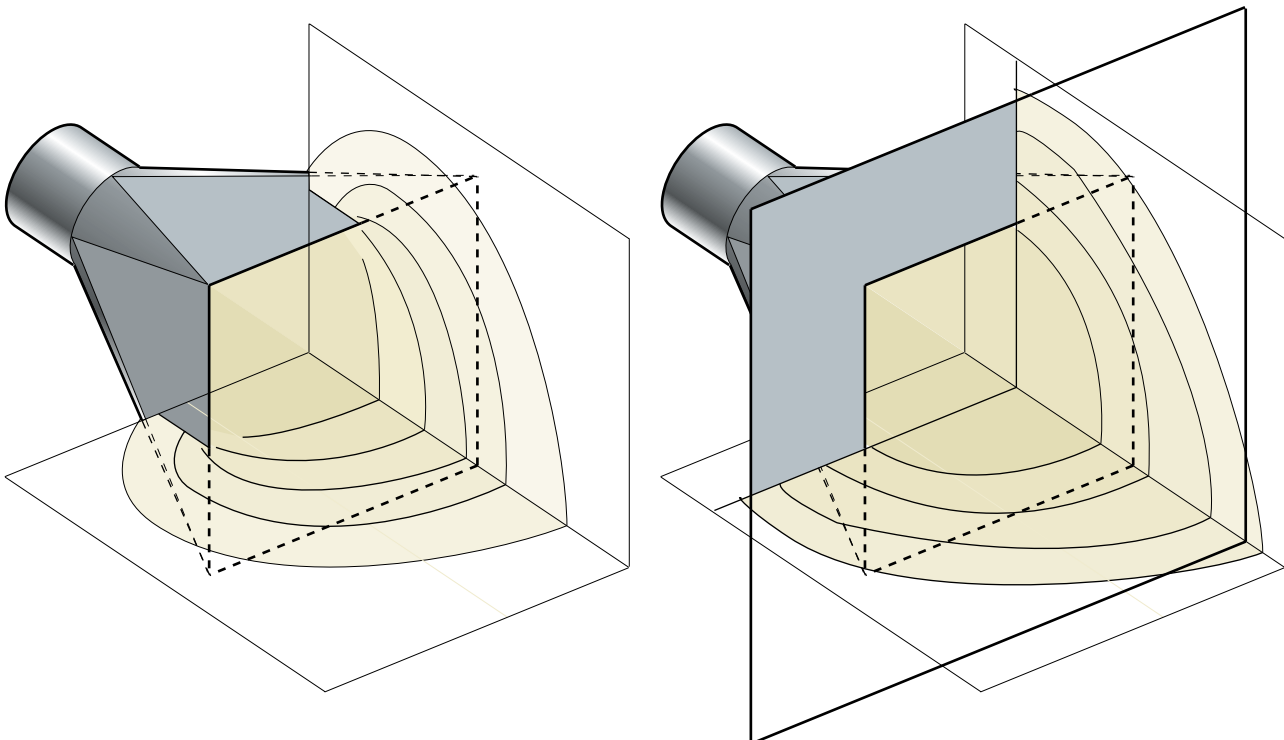

Note: The relative effectiveness of a flange increases as the hood aspect ratio increases, ie flanges have a greater effect with a slot-shaped hood.

Figure 32 The effect of flanges on capture hood velocity contours

Specific examples of capturing hoods

Rim or lip extraction

152 This is extraction along one or more sides of a source such as a tank with an open surface. A slot (a long, narrow hood) is required to extend along the length of the source. However, the capture zone for a slot is very limited, and where there are slots down both sides of a tank the capture zones need to meet in the middle.

153 As a rule of thumb, surfaces up to 0.6 m wide require a slot along one side, and surfaces between 0.6 and 1.2 m wide require slots down both sides. Control of a wider surface is impractical using rim or lip extraction – controlling emissions needs a different solution.

Downdraught table

154 Air is extracted downwards, typically through holes or slots in a horizontal surface, into a plenum chamber. The working zone is at, or very near to the extracted horizontal surface or hood face. The LEV-induced airflow shapes and constrains the movement of the contaminant cloud generated by the work process or activity.

155 The effectiveness of downdraught hoods depends on:

- the size and speed (velocity) of process-induced contaminant cloud movement relative to downdraught hood airflow (small hoods will not cope with large, 'energetic' processes such as high-speed disc cutting);
- how close to the hood face the work is done;
- the degree to which the hood face is blocked off by, for instance, components and other materials.

156 Large face-area downdraught hoods, relative to the processes being controlled, can effectively control contaminant clouds. Adding enclosing walls, and even a partial top, makes the hood into a partial enclosure and improves control effectiveness.

LVHV extraction

157 Some industrial tools, such as grinding wheels, have a rapidly moving surface. These surfaces also carry with them a layer of air moving at high speed (a boundary layer). Fine dust particles can be carried in this boundary layer and, because of the high speeds involved, they can be difficult to capture.

158 LVHV involves a small hood with a high face velocity, eg 100 m/s, located very close to the source. Typically, LVHV is applied in hand-held tools, but can be used with fixed equipment.

159 LVHV can be built into a rotary sander to successfully control the escape of dusty air (see Figure 30). It is difficult to retrofit LVHV. Designers of hand-held equipment that incorporates LVHV should apply ergonomic principles for user-acceptance and successful control.

Table 10 Capturing hood: Design principles

| | |
|------------------|--|
| Location | <p>Locate as close to the source as possible, normally less than one hood diameter away</p> <p>The capture zone should be large enough to encompass the working zone</p> <p>The capture zone should be defined, marked on the workstation and/or indicated on the hood labelling</p> <p>Avoid or suppress draughts</p> <p>Consider making prototypes</p> |
| Hood | <p>The shape of the hood should be similar in size and shape to the source and contaminant cloud</p> <p>It should be flanged or have a flared inlet with further enclosure where possible</p> |
| Airflow | <p>Adequate to create a large enough capture zone</p> |
| Usability | <p>Define and mark out the capture zone</p> <p>Design a moveable, adjustable hood or moveable workstation to keep the working zone within the capture zone. If not practical, apply a different LEV hood design</p> <p>Provide a visible display of adequate airflow such as a manometer on the hood duct</p> <p>Design the hood and work methods based on good ergonomic principles</p> |
| Draughts | <p>Move the hood and source closer together, eg use a more enclosing hood</p> <p>Increase the volume flow rate. Suppress draughts</p> |

Chapter 7 Designing the rest of the system

Key points

- The system must work to its specified performance and withstand wear and tear.
- The system components should be easy and safe to check, inspect, clean, test and maintain.

160 This chapter describes the rest of the system and the work environment.

Introduction

161 Chapter 6 discussed the size, shape, design and placement of the hood. It explained how the extract air velocity and volume are critical to a hood's success. The 'job' of the rest of the LEV system is to extract the right air volumes from the hood(s). There are key issues to address when designing the rest of the system, such as ductwork, air movers, air cleaners, and discharge to atmosphere and air recirculation.

Design

162 The rest of the LEV system should conduct the contaminated air away for cleaning or discharge. In all but simple systems, the design of LEV systems should be 'iterative', developing through the design process. The designer should:

- plan the layout – the initial design;
- specify the volume flow from each hood in a custom design;
- establish the flow rate and total pressure at each junction;
- plot the design in standard-size ductwork;
- recalculate the flows to establish where these deviate from the initial design;
- adjust the flows to the required values using tapers or slide valves;
- recalculate to generate a 'system curve' to show the volume of air moved through the system for any given pressure at the air mover. (Also see 'Fan characteristics' in paragraphs 197–201.)

163 Calculations that may be useful for designers can be found on the LEV pages of HSE's website, eg:

- air density – adjustment for temperature;
- air velocity from pressure difference;
- circular duct cross-sectional area;
- maximum vapour concentration for a liquid;
- conversions between ppm and mg/m³ for vapours and gases.

Ductwork

164 Ductwork¹⁶ connects the components of a ventilation system and conveys the contaminated air from the LEV hood to the discharge point. It consists of some or all of the following:

- ducting from the hood;
- dampers to adjust or balance the flow in different branches of the LEV system;
- bends, junctions and changes in the duct diameter;
- markings, including test points and hazard warnings of the duct contents;
- a connection to the air cleaner and air mover;
- access panels for cleaning and inspection.

165 Usually all the above are under negative pressure (ie lower than that in the workplace). Ducting on the discharge side of the air mover will be under positive pressure (ie higher than that in the workplace).

166 Ducts can be either circular or rectangular in cross-section. Circular ducts are generally preferable because they:

- have a lighter structure for a given cross-sectional area;
- have a greater ability to withstand pressure differences;
- produce less noise, as there are no flat panels to act as secondary sources of vibration.

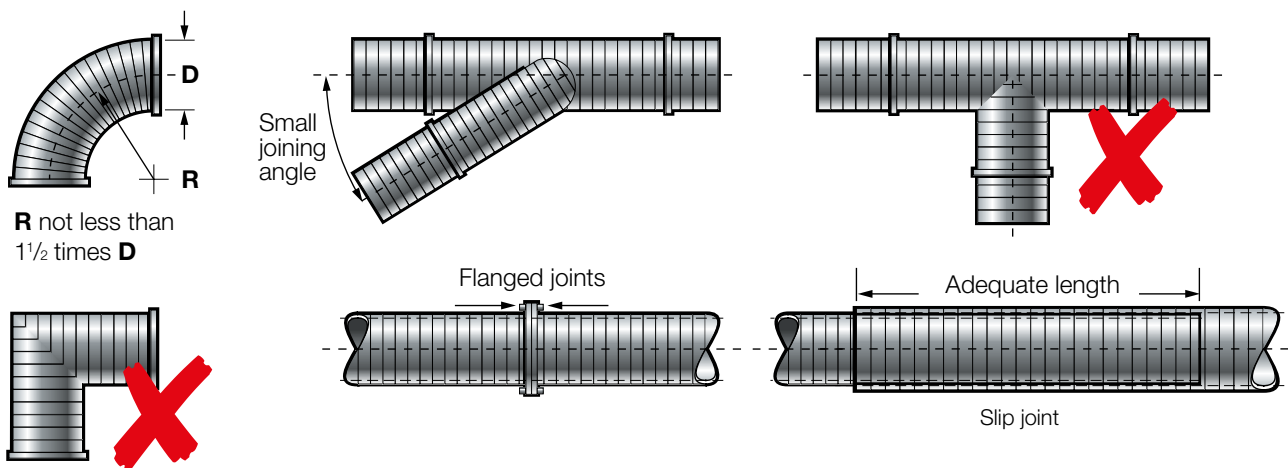

Figure 33 Bends, junctions and joints in ducting

167 The following points should be taken into account with regard to ductwork.

- Keep the design as simple as possible.
- Provide smooth-bore ductwork and an obstruction-free interior for particle extraction.
- Have a sufficiently high air velocity to keep particles suspended in the air stream, while low enough to keep noise levels acceptable.
- Route ductwork to minimise noise nuisance.
- Keep duct pressures negative within the building, as far as possible.
- Have the minimum number of bends and junctions to minimise the flow resistance.
- When changes of direction are necessary, they should be made smoothly. Junctions and changes of section should also be smooth. Do not use T-junctions.
- Incorporate tapered sections when the duct cross-section needs to change.
- Provide drainage points at any low points in an LEV system for aerosols, mists, or substances that may condense or support combustion.
- Provide access points as appropriate for cleaning and to clear blockages.
- Minimise the length of horizontal run for transport of particles.
- Depending on the expected range of temperatures, the ducting should accommodate thermal expansion and contraction.

168 The following should be avoided:

- long lengths of flexible ducting, which have high flow resistance and low resilience. Flexible ducts can wear, split and are easily damaged;
- sharp bends, as they cause particles to accumulate and block the duct (see Figure 33).

169 Ductwork must not violate the fire compartments of the building.^{17,18}

Materials for duct construction

170 Taking into account the physical conditions and chemical nature of the contaminants, the materials should:

- give the best resistance consistent with cost and practicability;
- have sufficient strength and supporting structures to withstand likely wear and tear.

171 The wall thickness^{19,20,21} should vary according to what the ducts will transport, for example:

- 'light duty' ducts for non-abrasive materials (eg paint spray, mist, wood dust, food products, pharmaceuticals);
- 'medium duty' ducts for non-abrasive materials in high concentrations, or moderately and highly abrasive materials in low concentrations;
- 'heavy duty' ducts for highly abrasive materials (sand, grit, rock, fly ash). Consider providing 'sacrificial' units – easily replaced parts of the duct, eg bends.

172 Galvanised sheet steel is suitable for many applications, particularly at high temperatures. Coated mild steel may be required to resist chemical attack. These materials also give some degree of fire protection. For non-corrosive low-temperature applications, aluminium or plastic (PVC, polypropylene) may be suitable. Table 11 gives suggested wall thicknesses for galvanised steel, based on durability.

Facilities for duct examination

173 Where appropriate, provide leak-proof inspection covers to facilitate inspection and cleaning inside ducts. These need to be accessible and simple to open.

174 Provide test points – as a minimum, 'static pressure tapings' in ductwork to monitor the system or to diagnose deterioration or partial blockages:

- after each hood or enclosure;
- at key points in the duct system;
- at certain components to measure pressure drops, eg across fans and filters.

Table 11 Ductwork wall thicknesses for galvanised steel

| Duct diameter in millimetres | Thickness in millimetres | | |
|------------------------------|--------------------------|-------------|------------|
| | Light duty | Medium duty | Heavy duty |
| 0 to 200 | 0.8 | 0.8 | 1.2 |
| 200 to 450 | 0.8 | 1.0 | 1.2 |
| 450 to 800 | 1.0 | 1.2 | 1.6 |
| 800 to 1200 | 1.2 | 1.6 | 2.0 |
| 1200 to 1500 | 1.6 | 2.0 | 2.5 |

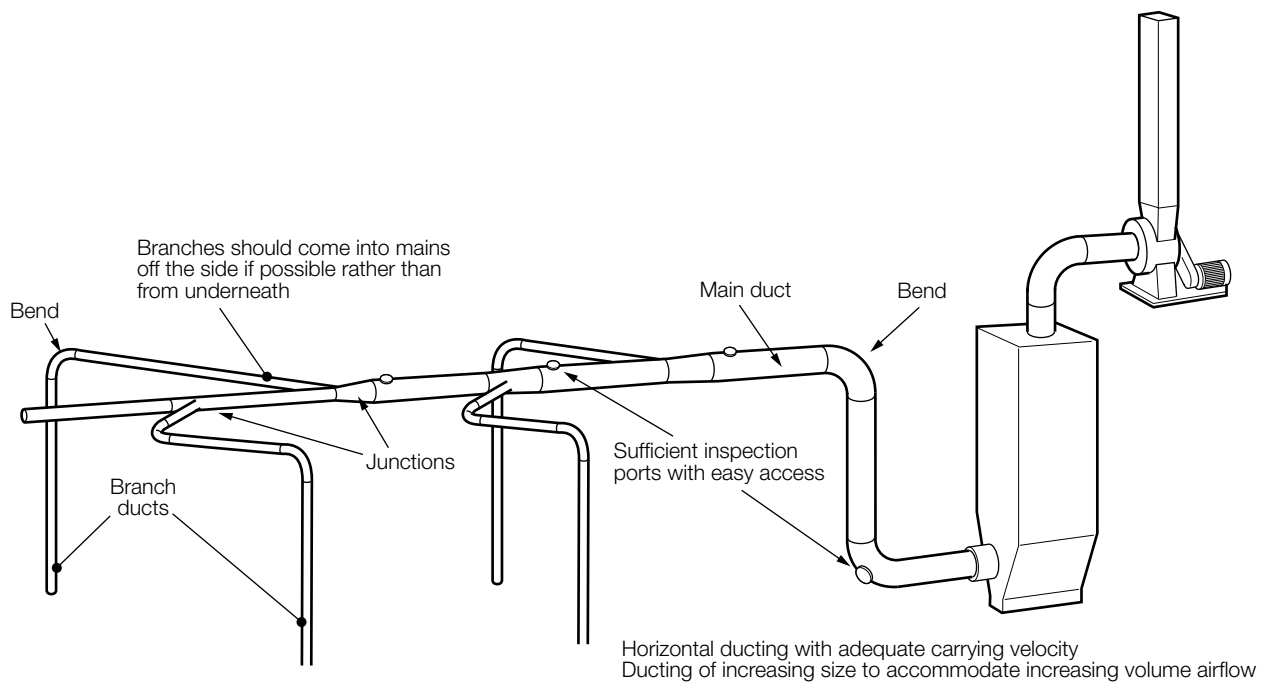

Figure 34 A multi-branch LEV system

175 Mark the ducts to show where these points are. Consider providing a suitable way to provide safe access to them.

Duct (transport) velocities

176 The air velocity through the duct must be high enough to keep particles suspended in the air stream. It should also be high enough to suspend and remove particles that settle out when the system stops. The designer needs to avoid deposition in any part of the ductwork. This is a particular problem:

- in long horizontal runs of ducting;
- at low points;
- at junctions where the duct diameter increases;
- after junctions or bends;
- when conveying large and small particles together, eg woodworking dusts.

177 Accumulation of settled particles reduces the diameter and shape of the duct, increases resistance and reduces the airflow in the system. Settled particles are difficult to re-entrain in the airflow and can lead to duct blockage and fire risk from flammable materials.

178 The required transport velocity depends on the type of contaminant being conveyed. Table 12 recommends some minimum velocities.

Ductwork performance

Multi-branch LEV systems

179 The design should provide the required velocity to bring contaminated air from the hood furthest away from the air mover (either in terms of distance or system resistance) to the air mover. It is common for several hoods to feed into a main duct. The fan must have enough power to move air at the required velocity throughout the system when the maximum number of hoods is in use. To reduce cost, it is desirable to isolate unused hoods, eg using dampers.

180 Dampers give a degree of flexibility, but the system can easily get thrown out of balance if they are tampered with. For this reason, whenever possible, it is preferable to avoid giving operators the control of dampers. For industries where dampers are common (eg in woodworking), operators should have good information on damper use, and effective supervision.

Table 12 Recommended minimum duct velocities

| Type of contaminant | Indicative duct velocity, m/s |
|---|-------------------------------|
| Gases and non-condensing vapours | 5 |
| Condensing vapours, fume and smoke | 10 |
| Low or medium density, low moisture content dusts (plastic dust, sawdust), fine dusts and mists | 15 |
| Process dust (cement dust, brick dust, wood shavings, grinding dust) | Around 20 |
| Large particles, aggregating and damp dusts (metal turnings, moist cement dust, compost) | Around 25 |

Varying the volume flow in the LEV system

181 Where the client anticipates changes in the volume flow rate, such as isolating unused hoods, the design options to cope with these changes include:

- a variable speed fan drive, where the fan speed varies to maintain a constant static pressure within the duct;
- fan belt or pulley drive changes, which require technical intervention;
- dampers, which are not energy efficient.

182 See Chapter 8 for information on balancing an LEV system. This is highly skilled work, particularly for a multi-branch system.

Pressure losses

183 Every hood, duct element and air cleaner of an LEV system is associated with a 'pressure loss'. The designer should add up the pressure losses due to each component of the system to select a fan that will overcome the airflow resistance of the ductwork and the fittings. There are several ways of doing this, for example:

- 'American method': Treat bends and fittings as having a pressure loss equivalent to a certain length of straight ductwork.¹⁵
- 'British method': Treat the straight runs of ductwork separately from bends and fittings. The designer calculates the pressure loss for each component, added to the ductwork pressure loss. This calculation is made at a stated volume flow rate.²²

184 Examples of how to calculate pressure losses can be found on HSE's LEV web pages.

Connections between the ducting and fan

185 Air should enter and leave the fan as a uniform flow with minimum turbulence. Bends and junctions in ducting near the fan cause either swirling (on the negative pressure side) or increased static pressure (on the positive pressure side), which reduce efficiency. Ideally, bends on the discharge side of a centrifugal fan should be at least five duct diameters downstream.

Fans and other air movers

186 The fan is the most common air mover. It draws air and contaminant from the hood, through ductwork, to discharge. There are five general categories of fan:

- propeller;
- axial;
- centrifugal;
- turbo exhauster;
- compressed-air-driven air mover.

Propeller fans

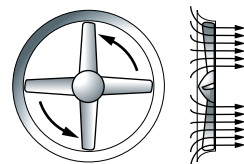

187 Propeller fans are often used for general or dilution ventilation. They are light and inexpensive to buy and run, with a wide range of volume flow rates. However, they will not produce much pressure and operate best against low resistance.

188 The fan blades are of sheet material (metal or plastic) mounted in a plate or cage and on a hub that is attached directly to the shaft of an electric motor, or belt driven. Generally, they are unsuitable for ducted systems with a moderate resistance or with particle filters.

Axial fans

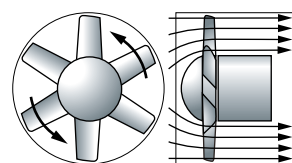

189 Axial fans are not suitable for dusts. They are compact, do not develop high pressures and cannot overcome the resistance to flow that many industrial applications require.

190 The impeller fan blades are on a rotating hub mounted in a short cylindrical casing. The fan is in the duct. Unless the contaminant is flammable or corrosive, the motor is also in the duct.

Centrifugal fans

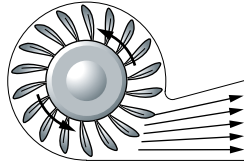

191 Centrifugal fans are the most commonly used fans for LEV systems. They generate large differences in pressure and can produce airflows against considerable resistance.

192 The impeller fan blades are mounted on a back plate, often within a scroll casing. Air is drawn into the centre of the impeller along the line of the drive shaft. The air is ejected at a tangent to the impeller.

Types of centrifugal fan

193 The blade shape characterises the type of centrifugal fan.

- Radial blade (most commonly, paddle type). These are robust, easy to maintain, clean and repair. They can convey heavy dust or product loads. Radial blades are often a solution for dusty contaminant clouds.
- Forward curved multivane. These have many relatively small blades. The blade tips incline towards the direction of rotation. Rotational speed is usually lower than with other types of centrifugal fan. Forward curved multivane blades may be unsuitable for dusty contaminant clouds.
- Backward bladed (curved, flat, laminar, aerofoil). These can overcome high system pressures. With high dust loads, dust can accumulate on the impeller which can lead to imbalance and vibration.

Turbo exhausters (multi-stage centrifugal)

194 Turbo exhausters can generate the high suction pressures needed to power LVHV systems; they are not conventional fans. They use high-precision blades that are susceptible to damage by dust and require a filter to protect the exhauster.

Compressed-air-driven air movers

195 Compressed-air-driven air movers are appropriate where electrically-powered fans are unsuitable, eg where access is difficult, or where there are flammable gases. They are small, inexpensive and easily portable. Their main disadvantages are the high running cost (compressed air is expensive) and high levels of noise for relatively small amounts of air moved.

Fan location

196 The objective is to have as much of the ductwork as possible under negative pressure. In particular, indoor ductwork upstream of an air mover should normally be under negative pressure. Leakage in this ductwork will then be inward and contaminated air should not escape into the workplace. One solution is to locate fans and positively pressurised ductwork outside occupied areas.

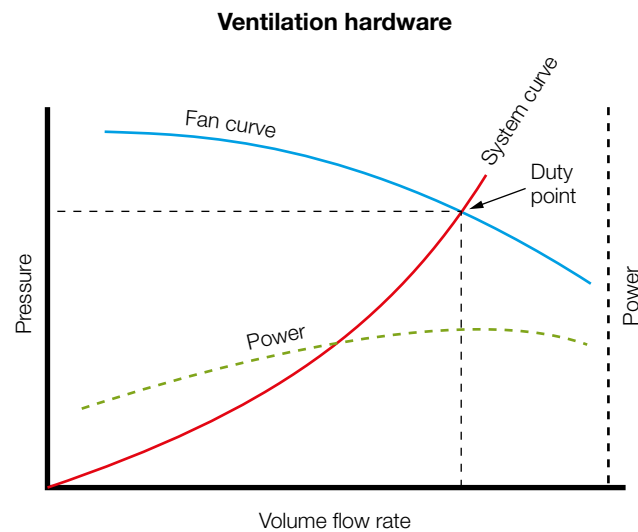

Figure 35 Fan curve showing intersection with system curve

Fan characteristics

197 The efficiency and noise characteristics of fans vary significantly between fan types, sizes, speed and how they are used. The power required from the fan, and its efficiency, vary with the volume flow rate. The curves of pressure, power and efficiency against volume flow rate are known as 'fan curves' (see Figure 35). Fan manufacturers' catalogues present these curves for each of their fans, and provide information to help choose the right fan.

198 The 'system curve' shows the volume of air moved through the design for any given pressure at the air mover. An air mover should be selected that is capable of moving at least this volume of air at that pressure difference – the fan curve.

199 The fan should be selected so that system and fan curves cross at the design pressure and flow point (the duty point). It is often necessary to use a variable controller or restriction valve to move the fan curve so that this and the system curve cross where needed.

200 The 'duty point' gives data to specify the fan for the system – the pressure and power for the required volume flow rate. In fact, Figure 35 is rarely plotted; the duty point is selected from the system curve and a table of fan characteristics. However, a graph of the curves does show whether the duty point is in a stable area, ie whether minor leaks, blockages or defects would cause a drastic deviation in the system performance with a chosen fan.

201 It is important to ensure that the duty point is within the optimum range of the fan. Operation outside this range leads to an increase in noise and power consumption. That can overload the fan, leading to system failure.

Fan selection

202 For a particular application, many factors should be considered for fan selection. These include:

- the type of substance in the contaminant cloud;
- flammability or combustibility;

- the airflow required;
- the system resistance characteristics;
- the fan pressure characteristics;
- space limitations;
- the method of mounting the fan and the type of drive;
- the operating temperature;
- acceptable noise levels.

203 More detailed information on fans, their application and selection can be found on the Fan Manufacturers' Association website (see 'Useful contacts') and in a joint CIBSE publication, *Fan application guide*.²³

Air cleaners: Particles

204 Particle collectors are the most common group of air cleaning devices associated with LEV systems. The group consists of fabric filters, cyclones, electrostatic precipitators and scrubbers.

Fabric filters

205 These are suitable for dry dusts. Dusty air passes one way through a fabric layer that is flexible and porous. The fabric may be constructed and treated to carry electrostatic charge which help attract and retain dust. Particles are removed by:

- impaction, where particles, larger than the weave, meet the surface of the filter;
- impingement, where medium-size particles meet the fibres within the filter weave;
- diffusion, where small particles are attracted towards the fibres.

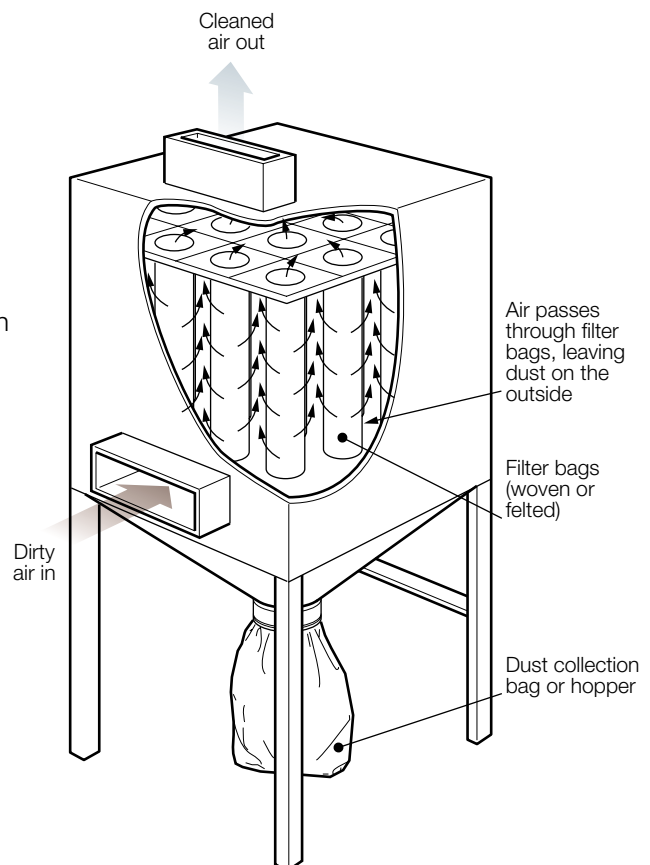

Figure 36 Bag filter unit

206 The main ways to clean filters are:

- mechanical shaking;
- reverse airflow;
- pulse-jet.

207 The cost of the filter material is a major expense. It is also an operating cost as filters need periodic replacement before they fail. The designer should specify the replacement interval, which is normally between one and four years.

Cyclones

208 Cyclones consist of a circular chamber, tapered at the bottom. Dusty air feeds at a tangent into the top of the cyclone and swirls around the chamber. This throws particles out to the wall by centrifugal action. The particles' velocities decrease and they fall to a collection hopper at the base of the cyclone. Cleaned air passes through a central outlet in the top of the cyclone. The larger the particle, the easier it is for a cyclone to remove it from the air.

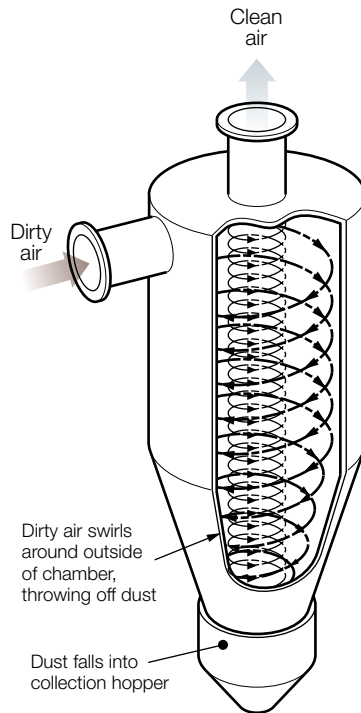

Figure 37 Cyclone dust separator

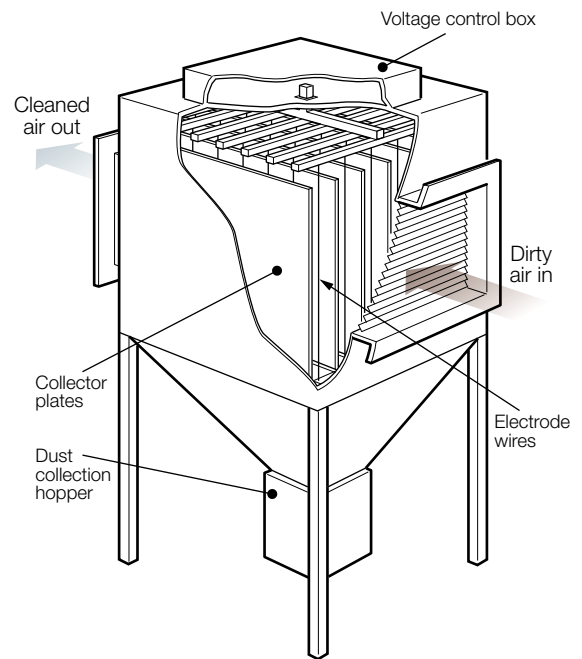

Figure 38 Electrostatic precipitator

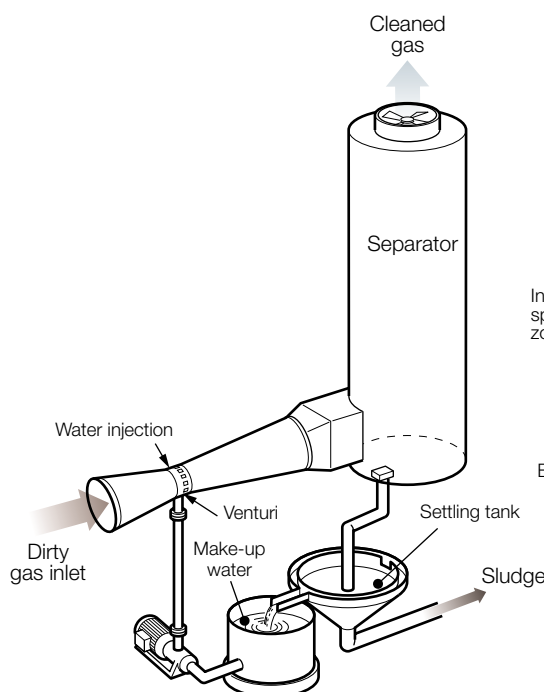

Figure 39 Venturi scrubber

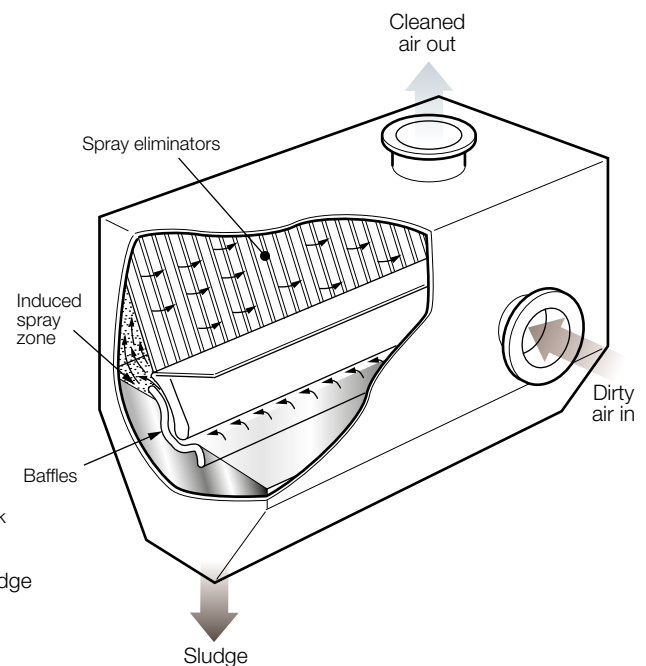

Figure 40 Self-induced spray collector

Electrostatic precipitators

209 Electrostatic precipitators are suitable for fine dusts, but unsuitable for heavy contamination. They give dust and fume particles an electrical charge and attract them onto collecting surfaces with an opposite charge. Cleaned air flows out of the device. There are two classes of design:

- pipe or tube, where a high-voltage wire lies along the axis of a grounded tube;
- parallel plate, where a series of high-voltage wires lie between a series of grounded metal plates.

Scrubbers

210 'Scrubbing' means wetting particles and washing them out of a contaminant cloud. The design requirements are to:

- wet the particles;
- cause them to settle out in water;
- provide a suitable disposal system;
- prevent dust building up at the inlet;
- prevent water carry-over in cleaned air.

211 There are numerous designs of scrubbers, the most common being venturi scrubbers, self-induced spray collectors and wet cyclone scrubbers.

Venturi scrubbers

212 Dusty air passes through a narrow venturi throat which has water injection. The conditions in the throat are highly turbulent. The water separates into small droplets that collide with the dust particles. A cyclone separates the droplets to produce a sludge containing the dust. Cleaned air passes through a central outlet in the top of the cyclone.

Self-induced spray collectors

Dusty air is drawn under a baffle in a water trough. The dust impacts on droplets and also on water in the trough. A 'spray eliminator' or 'drift eliminator' separates water droplets from the cleaned air. The contaminant settles out as sludge at the bottom of the collector. To avoid bacterial infection and consequent bad odours, spray collectors need regular cleaning. There may be a legionella risk.

Wet cyclone scrubbers

214 Dusty air enters a cyclone collector that has a centrally located water spray directed outwards. The cyclone separates the droplets, producing sludge from the dust. Cleaned air passes through a central outlet in the top of the cyclone.

Table 13 Air cleaners – particles

| Type | Approximate collection efficiencies | Advantages | Disadvantages |
|--|---|---|--|
| Fabric filter | Can rise to over 99.9% | <ul style="list-style-type: none"> ● Fabric filters increase in efficiency as the dust 'cake' builds up | <ul style="list-style-type: none"> ● Flow resistance increases as the dust cake builds – airflow falls ● Greasy or waxy materials can clog the filter permanently ● Abrasive materials cause rapid wear |
| Cyclone | 2 µm particle – zero 5 µm particle – 50% 8 µm particle – 100% | <ul style="list-style-type: none"> ● The pressure drop is small compared with other dust collectors ● Good efficiency for larger particles | <ul style="list-style-type: none"> ● Poor collection efficiency for small particles |
| Electrostatic precipitator | 1 to 5 µm – 80 to 99% 5 to 10 µm – 99%+ | <ul style="list-style-type: none"> ● High temperatures and corrosive conditions ● Fairly low running costs ● Low pressure drop (50 to 200 Pa) | <ul style="list-style-type: none"> ● High investment cost ● Quite large ● Limited flexibility on changes in operating conditions ● Performance may be poor for particles with very low or very high electrical conductivity ● Shorting and sparking when very dirty ● Requires specialist cleaning |
| Wet scrubber (venturi, spray collector, wet cyclone) | More than 5 µm – 96% 1 to 5 µm – 20 to 80% | <ul style="list-style-type: none"> ● Hot gases ● Removes sticky particles without clogging ● Eliminates fire and explosion hazards ● Dust-free disposal | <ul style="list-style-type: none"> ● High noise levels ● Corrosion ● Freezing in cold weather ● Disposal of slurry and polluted water ● Some dusts are difficult to wet ● Bacteria and bad smells |

Air cleaners: Gases and vapours

215 The technologies used include destruction methods, packed tower scrubbers and recovery methods.

Destruction methods, such as thermal oxidation (incineration) or flare

216 Gases or vapour are destroyed before discharge by burning or thermal oxidation. Thermal oxidiser units can be fitted with heat recovery that partially offsets the fuel costs.

Packed tower scrubbers for substances that mix with water

217 A tower is filled with packing to provide a large surface area. Water or a reagent solution flows in at the top of the tower and contaminated air enters at the bottom. Trickling fluid absorbs the contaminant and cleaned air emerges at the top. To avoid bacterial infection and consequent bad odours, tower scrubbers need regular cleaning. There may be a legionella risk.

Recovery methods, such as adsorption

218 Contaminated air passes through filters that remove gases and vapours. Activated carbon filters are the most common. Air is usually filtered of particles before being passed through a carbon filter. Regeneration of carbon filters and solvent recovery is feasible, but recovery becomes viable only when the solvent usage is high. Impregnated carbons are able to absorb specific chemicals. Typical disadvantages include:

- a frequent requirement to change the filter;
- the filter fails suddenly when saturated;
- carbon can develop 'hot spots' that need detectors and fire-extinguishing systems.

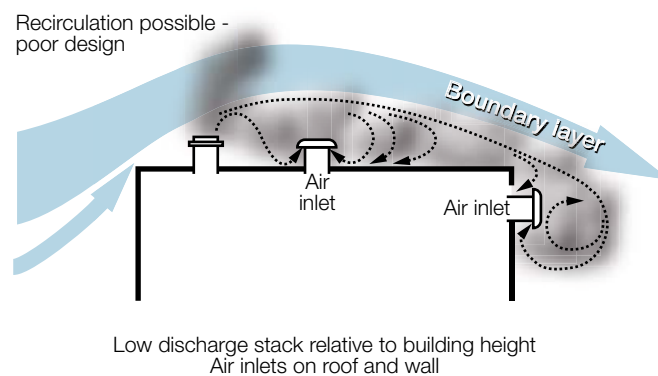

Figure 41 Location of discharge stack

219 Caution: charcoal filters are **not** particle filters.

Discharge to atmosphere

220 Whether or not it has been cleaned, extracted air must not re-enter the building or enter other buildings unless the contaminant has reached negligible concentrations. Discharged air must leave the discharge duct at a high enough speed to make sure it is dispersed. Discharge is normally via a 'stack'.

Stack siting

221 The airflow patterns around a building are complex. The objective is to ensure the air is discharged beyond the recirculation eddies to prevent it being re-entrained. The discharge point should be located well above the highest point of a building.

222 The designer should know the airflow patterns around a new installation's building, ie the:

- recirculation eddy produced by the leading edge of the roof;
- downwind wake;
- effect of wind direction.

Stack design

223 Exhaust leaves a discharge stack and rises due to its momentum and/or buoyancy. Once its energy has decayed and the air cooled to ambient temperature, the plume is carried by the prevailing wind.

224 Increases in the velocity of the final discharge can be achieved by putting a tapered nozzle on the outlet. Taller stacks prevent the mixing of discharged air with the boundary layer air, but these may not gain planning approval. The Environment Agencies (EA, SEPA) or local authorities may have stipulations for stack height.

225 Other ways of increasing the plume velocity are:

- grouping exhausts into fewer stacks;
- placing exhausts very close together so that plumes merge.

226 Avoid rain caps and other devices that reduce upward vertical velocity. Never use devices that direct the discharge downwards (see Figure 42a).

227 In some circumstances, discharges will be subject to controls on discharge to the atmosphere etc. There are separate Pollution Prevention and Control (PPC) Regulations in England and Wales, Northern Ireland and Scotland.

LEV instrumentation

228 Users of LEV systems, particularly the operators at LEV hoods, must be able to tell that the hood airflow is still adequate to control exposure. Good practice requires the periodic monitoring of performance for all hoods. The designer should therefore specify suitable monitors such as manometers or other airflow indicators.

Airflow indicators

229 Airflow indicators cover a wide range of equipment:

- a simple and reliable device such as a manometer connected to the hood duct. The static pressure is a direct indicator of the airflow rate;
- a complex device, eg a pressure switch to activate an alert if the flow drops below pre-set trigger levels (see BS EN 14175 *Fume cupboards. Safety and performance requirements*²⁴).

Manometers

230 Manometers are pressure gauges that indicate 'static pressure'. They come in several forms:

- electronic (pressure transducer);
- mechanical (pressure-sensitive diaphragm), which requires no power and is safe for flammable atmospheres;
- liquid in glass, which requires no power, is safe in flammable atmospheres and is cheap and precise. The disadvantages are that air bubbles may form in the liquid, or the liquid may evaporate.

Alarms and indicators

231 Alarms can fail without warning. It is good practice to specify in the user manual the frequency of alarm testing. The designer needs to specify the appropriate intervals between tests for alarms and indicators.

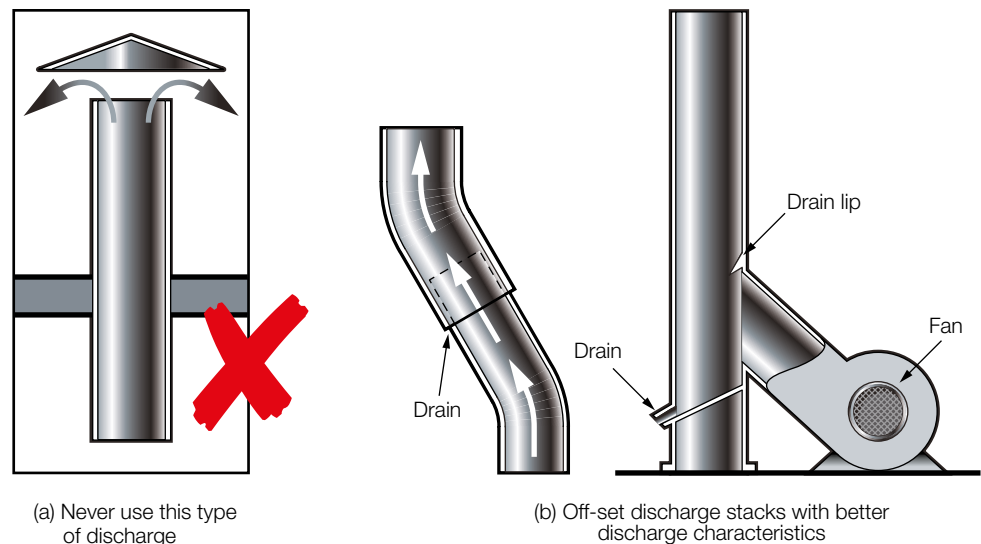

Figure 42 Stack design

Work environment and process issues

Recirculation of extracted air

232 Recirculating extracted air is a way to save energy and reduce heating or cooling costs. It also reduces the need to consider make-up air. Recirculation is easier with:

- contaminants which are particles;
- low concentrations of airborne contaminant compared with the 'benchmark' value (Chapter 3);
- relatively small LEV systems;
- lower toxicity materials.

233 The air cleaner is the most important part of a recirculation system. It must match the contaminant and its concentration. Recirculation is acceptable as long as the air is thoroughly cleaned. When failure of a component such as an air cleaner could result in dangerous conditions, any recirculation system should incorporate monitoring and alerts, for example:

- an alarm for a blocked or failed filter, eg a pressure gauge for continuous monitoring;
- an advanced detection system connected to alarms and a system to divert recirculated air out of the workplace.

234 Testing of detectors and alarms must be covered in the user manual (see Chapter 9).

Recirculating fume cupboards

235 Recirculating fume cupboards that are used to control dust, mist or fume should be fitted with a high efficiency particulate air (HEPA) filter. The filter seating should be checked every time it is changed and the system needs continuous monitoring.

236 Adsorption filters may be used where it is possible to predict when the filter is likely to fail and it is uneconomic to install a suitable monitor, eg a flame ionisation detector (FID).

Make-up or 'replacement' air

237 Extracted air needs planned replacement, otherwise severe draughts may be generated which may compromise the effectiveness of an LEV system. The LEV would not then perform as designed. Make-up air is an integral part of an LEV system and heating it is an important running cost. The volume of make-up air must match the volume of air extracted. For small LEV hoods in large workrooms natural ventilation may provide enough make-up air. For large LEV hoods in small workrooms fit passive or active inlet vents.

238 Typical signs of an inadequate supply of make-up air include:

- fumes from a naturally-ventilated flue enter the workplace;
- doors opening out of the workplace are difficult to open;
- doors opening inwards are difficult to close;
- draughts whistle under doors and through window frames;
- the fan may become more noisy;
- the flow through the hood increases on opening a door or window;
- a pilot light on a gas appliance may go out.

239 One common cause of make-up air supply failure is stacked materials or rubbish blocking inward air vents.

240 Make-up air should not create draughts or disturb the airflow into an LEV hood. The size of openings to allow ingress of make-up air should be such as to minimise such effects and they should be sited away from hoods.

General workroom ventilation

241 LEV might not be the right control solution when:

- there are a large number of widely-spaced sources;
- the source is large and LEV is impossible to apply over the entire source;
- the source position is not fixed;
- the source emits relatively small amounts of contaminant;
- the contaminant is offensive but not harmful.

242 The employer, working with the designer, may decide to have LEV to control the main sources and use general ventilation for minor sources or any loss of contaminant from large sources. General ventilation involves replacing contaminated workplace air with cleaned or fresh air. Dilution or mixing ventilation and displacement ventilation are two forms of general ventilation.

Dilution or mixing ventilation

243 Clean air dilutes contaminated workplace air by mixing with it. The assumption that the concentration of contaminant is uniform throughout the workplace is common but usually wrong. In practice, mixing is incomplete because there will be some areas with high local concentrations in the workplace, usually near sources.

Displacement ventilation

244 Clean air pushes contaminated air away with minimal mixing. This 'piston' or 'plug' flow can be produced by:

- introducing air at an even rate over a whole wall, displaced through the opposite wall;
- supplying air at a low point in the room that is a few degrees cooler than the workplace air. Warmer contaminated air displaces upwards for clearance (eg via louvres);
- supplying warm air at a high level and venting contaminated air at a low level.

245 For displacement ventilation, the clean air's velocity should be high enough to maintain a uniform flow and low enough to avoid general mixing. **Caution:** Successful large-scale displacement ventilation is difficult to achieve.

Special case: Local air displacement

246 Local air displacement (LAD) is not LEV since it does not extract air. It is appropriate for work in a defined and limited zone where other controls do not deliver an adequate reduction in operator exposure. LAD is a wide, slow-moving jet which supplies clean air to the operator's breathing zone, entering over a plenum. The flow entrains contaminated air at the edges, but the jet is wide enough to keep the contaminated air away from the operator's breathing zone (see Figure 43a). A high-speed narrow jet has a clean air core that will not extend to the operator's breathing zone and so is inappropriate (see Figure 43b).

247 LAD is intended to supply clean air to the breathing zone. LAD is not designed or intended to blow away contaminant clouds. It can be used alone or combined with an LEV system. The design principles for LAD are in Table 14 and the key features are:

- The air supply should be as close as practicable to the operator's breathing zone, but not be so close as to cause discomfort or restrict movement.
- The downward airflow must counteract any upward flow of air caused by the work process. The flow should be smooth, at around 1 m/s over the face of the plenum, with no swirling.
- The working area should be limited to the core of clean air which should be large enough to cover the working area.
- Ideally, LAD air should be at, or slightly below, the temperature of the workroom air. In cold working conditions, the designer should provide for radiant heaters to maintain thermal comfort.

Other issues

Noise

248 The employer should be aware of HSE guidance on the Control of Noise at Work Regulations²⁵ regarding the exposure of workers to the risks arising from noise and must ensure that the equipment will not increase the noise to an unsafe level on the premises. Noise generated by LEV can cause a risk to hearing. The supplier should provide information on noise emitted by the machinery. The noise originates from:

- fans – the type of fan, blade design, drive, bearings, mounting, casing, sound insulation and duct connection;
- turbulence caused by sharp bends, sharp changes in cross-section or internal duct flanges;
- high velocities and large particles;
- airflow around small, high-velocity capturing hoods;
- noise or vibration created elsewhere and propagated by hoods and ducting.

249 Where appropriate, the design should incorporate:

- anti-vibration mountings and sound insulation for fan assemblies;
- silencers or sound insulation for ducts;
- hoods designed so they do not generate excessive noise.

Thermal comfort

250 The air inlets should be designed to avoid creating cold draughts. It is important to ‘temper’ or take the chill off make-up air. This is a particular issue for work inside a booth with a large airflow rate and a light workload. An alternative to tempering may be to provide radiant heaters that are under the operator’s control.

Lighting

251 The employer should assess the ambient lighting in the area where the LEV is to be installed and inform the designer who can design additional lighting, if necessary, to meet the essential health and safety requirement 1.1.4 in SMSR 2008.⁷

252 Hoods reduce light and can make it difficult for the operator to see what they are doing. This can result in:

- the hood being moved aside, becoming ineffective; or
- the operator working outside or at the face of a booth, reducing its effectiveness.

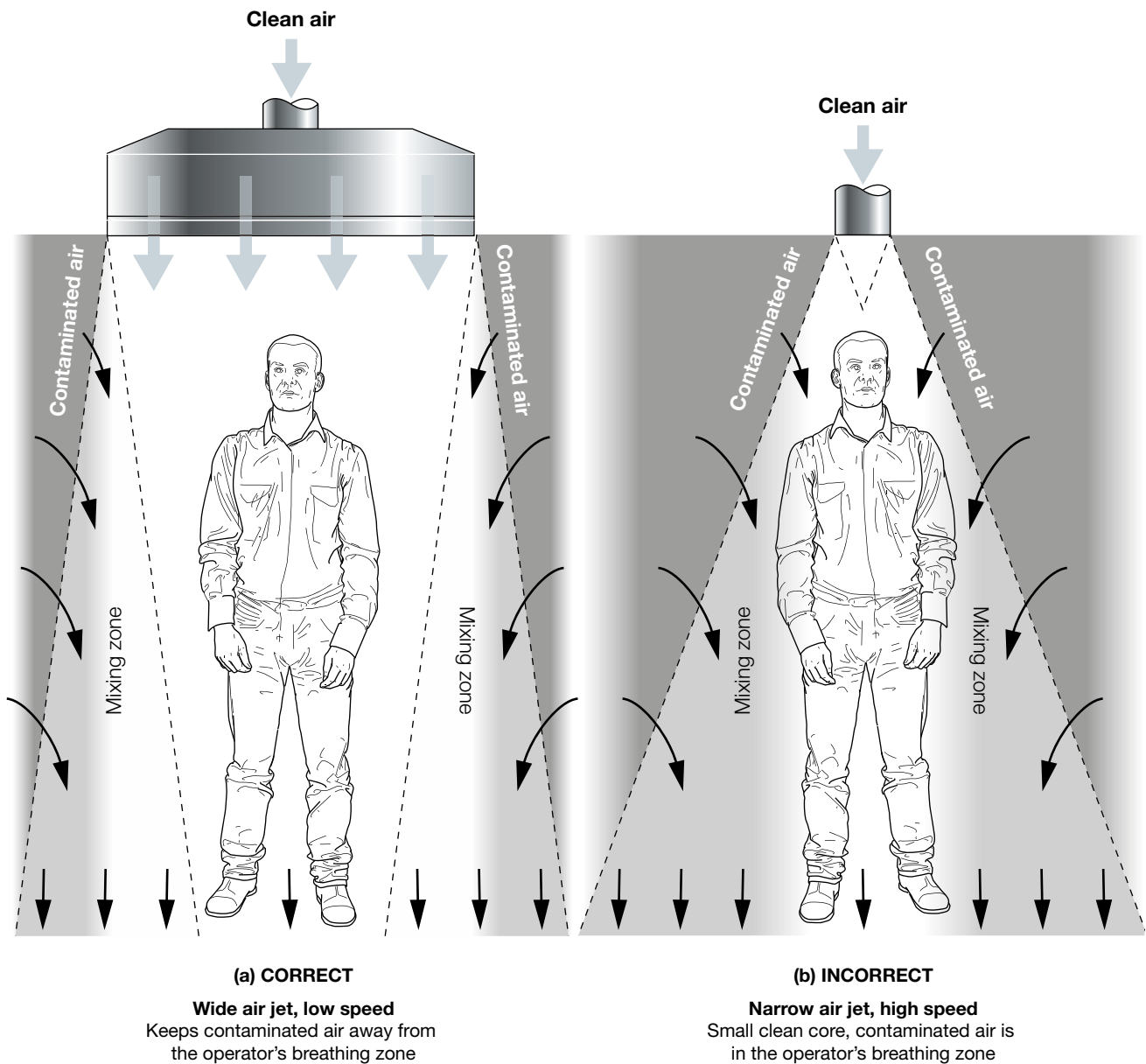

Figure 43 Local air displacement

Table 14 LAD: Design principles

| Issue | Potential solution |
|-------------------------------|--|
| Is LAD an appropriate option? | Consider process changes and LEV first |
| Well-defined working zone | Design LAD to cover the whole working zone Clean air must encompass the breathing zone during the task Minimise draughts |
| Positioning | Locate the plenum close to the operator's head |

| | |
|-------------------------|--|
| Airflow design | <p>Airflow should be sufficient to maintain a clean air core – 1 m/s at the plenum face may be adequate</p> <p>Airflows should be even, with no swirling or eddies</p> |
| Design uncertain | <p>Prototype the installation and test – iterative design</p> |
| Usability | <p>Locate airflow indicator near the plenum duct</p> <p>Radiant heaters may need to be available under the operators' control</p> |

253 Always design lighting for partial enclosures and walk-in booths. Consider designing a light source within moveable hoods.

Access

254 The design should incorporate the need for operator access. These needs include routine work activity, inspection, cleaning, testing, maintenance and repair. If access is difficult, it is less likely that the employee will carry out these necessary duties and so the LEV system performance will degrade.

Work operations

255 Operators need to move equipment into the hood easily or to move the hood to the process easily. They need to be able to manipulate objects during working and, for walk-in booths, to be able to work around the object. The designer may consider specifying a turntable or jig for easier positioning of the work.

Inspection, testing, cleaning, maintenance

256 The operators require safe and easy access to:

- inspection doors of a reasonable size;
- hatches for ducts liable to blocking or fouling;
- the air cleaner, eg for changing filters, emptying the waste hopper, drainage and sludge removal;
- fans and drives that require parts replacing.

Table 15 The rest of the LEV system: Design principles

| | |
|------------------|--|
| Location | Design for quiet running indoors |
| Ducting | <p>Provide airflow indicators, eg manometers, at hood ducts and at other necessary points</p> <p>Minimise bends and smooth junctions</p> <p>Make corrosion-resistant where necessary</p> <p>Include drainage points for liquid from mists</p> <p>Design as much of the duct as possible to run at negative pressure</p> <p>Anticipate wear points and plan for easy replacement</p> <p>Include access to clear blockage points</p> |
| Airflow | <p>Design for quiet running</p> <p>Smooth airflows and particle transport</p> <p>Deliver adequate make-up air</p> <p>Discharge to a safe place</p> |
| Usability | <p>Make sure there is safe and easy access to necessary parts of the system</p> <p>Take noise, lighting and thermal comfort into account</p> <p>Keep a stock of replacement parts</p> |

Chapter 8 Installing and commissioning

Key points

- The four stages for commissioning are installation, performance checks, assessment of control effectiveness and reporting.
- Testing and proving is critical.
- Existing LEV systems with no documentation should show effective control and have performance data measured and recorded.

257 This chapter describes the points to cover for installing and commissioning LEV.

Commissioning

258 'Commissioning' is proving that an LEV system is capable of providing adequate control. The final specification (see Chapter 5) lists the essential features for adequate control. The system needs to be installed and commissioned to be effective in practice. Certain parts of the commissioning process used to be referred to as 'initial appraisal' and 'intended operating performance'. This book does not use those terms but it incorporates their meaning. It also sets out a way of commissioning an existing undocumented LEV system.

259 The employer is responsible for effectively controlling exposure by means of adequate control measures, both 'hardware' such as LEV and work practices. This means:

- process-related equipment, eg seals, jigs, handling aids, as well as the LEV system;
- work practices, such as optimum work position, the angle and position of work tools and the correct use of the LEV.

260 Commissioning should cover both 'hardware' and work practices. LEV installers and commissioners ensure the set of control measures actually provides adequate control of the hazard.

261 Effective commissioning requires the employer to work closely with the LEV supplier and LEV service providers. Installation and commissioning may interrupt production.

262 There are four stages to LEV commissioning:²⁶

- installation (if necessary) and verifying that the system was installed as designed;
- showing that the LEV system meets the specified technical performance;
- control effectiveness – demonstrating adequate control of contaminant clouds;
- reporting findings (qualitative and quantitative) as benchmarks for management and maintenance of LEV performance and subsequent examinations and tests.

263 The LEV commissioning report, together with the user manual (Chapter 9), is the basis of the statutory 'annual' thorough examination test. Many LEV systems will not have been commissioned or supplied with a user manual. In these cases,

the employer will have little information on the required performance or how to maintain it. The LEV examiner may also have difficulties (see Chapter 10).

Stage 1 Installation

264 The installer may be the design or supply company, the service provider, or even the employer (if competent). Further information on 'competence' requirements for LEV installers appears in Chapter 2 and Appendix 1.

265 The installer may need to organise the following before installation:

- footings for heavy items of plant;
- power supplies;
- compressed air supplies;
- safe access;
- the co-operation of the employer and the employer's staff.

266 For simple systems, installation is generally limited to unpacking, assembling, checking that ducts are clear (eg free of packaging), and turning on and initial adjustment. For more complex systems, installation could involve:

- a completeness check, to ensure all components were supplied, of the right type, size and rating;
- verifying power and other service facilities (eg compressed air) and checking they are sufficient;
- constructing the LEV system;
- checking the assembly is correct, with testing and access points identified;
- checking all components are in good working order and the air mover fan is turning in the correct direction;
- rough balancing with any dampers set;
- remedy of any simple faults.

267 The installer should report any undocumented or missing parts and all modifications. Where there are problems installing the system as specified, the employer (as the client) and the designer or supplier must endorse any variations. For example, ductwork should not be 'shoehorned in' because of unforeseen space restrictions.

268 The process of installation may introduce health and safety hazards such as:

- work at height;
- manual handling;
- vehicle movements;
- machinery;
- fume from any welding;
- flammable atmospheres;
- electrical hazards;
- asbestos (encountered unexpectedly during work on the building fabric) – ask to see the client's 'asbestos management plan'.

269 The installer should discuss with the employer and agree how such risks are to be controlled. This book does not discuss these in further detail, but HSE has produced other publications which do, all available on the website. CDM2015 may apply to the installation of LEV plant.

Balancing the system

270 If the design of any LEV system includes more than one hood each branch should extract just the right amount of air. Installation involves much more than simply connecting up the ducts and turning on the fan. Balancing^{15,16,27} means achieving the performance required at every hood in a system. This must be done either by the installer, or by the commissioner. The airflow in each branch is determined by:

- inlet or hood resistance;
- duct branch length, diameter and flow resistance;
- flow conditions at the junction with the main duct.

271 Balancing is always required on installation, commissioning and on any reconfiguring of the LEV system. The correct balancing (and rebalancing) of an LEV system is a highly skilled activity, particularly on a multi-branch system. Altering the airflow in one duct affects the flows in all of the other branches. It is often necessary to work through the whole LEV system, and repeat the process at least once.

272 A common reason for an existing system to be seriously unbalanced at inspection is that somebody has isolated a redundant inlet, or added new hoods. In such cases, rebalancing is required, starting at each hood and branch and making adjustments while working towards the air mover. The American National Standards Institute (ANSI) has standards for balancing (see ‘Further reading’).

273 **Caution:** It is a mistake to rectify serious imbalances using just dampers. This can cause local areas of dust or liquid deposition and wastes power.

Table 16 Principles of installation

| | |
|----------------------|---|
| Specification | Needs to be clear and unambiguous |
| Installation | <p>Meets the specification</p> <p>Follows safe working practices – CDM 2015 may apply</p> <p>Variations need to be agreed with the designer</p> <p>Check thoroughly before handover for commissioning</p> |

Stage 2 Technical performance

274 The new system must perform to the standards and benchmarks that the employer specified. All systems need commissioning, and recommissioning, when there are:

- changes in the process;
- changes in the workplace layout;
- any changes of the equipment creating the source;
- any other changes such as modifying a branch or adding a new branch.

275 Information on ‘competence’ for LEV commissioners appears in Chapter 2 and Appendix 1.

Large systems

276 Certain large systems, for example those commonly found in woodworking, are specified to connect to more hoods than the air mover and cleaner are designed to extract simultaneously. Many hood ducts have 'blast gate dampers' to isolate hoods that are temporarily unused. The system and its limitations should be documented and the user trained to use these dampers. The supervisor should know which duct combinations may be open at the same time. This information should be displayed in a plan or diagram.

Technical performance testing

277 The LEV commissioner uses various assessment methods. The outcome of observation, testing and measurement is the commissioning report. This sets the benchmarks and standards against which the employer compares the results of statutory testing (see Chapter 10). It also sets the benchmarks for tests in the logbook for the system. The tests include measurements of:

- the volume flow rate at various points in the system including hood faces (where appropriate), hood ducts and the main duct;
- static pressures in various parts of the system including hood ducting, and across the filter and fan;
- hood face velocities (where appropriate);
- the fan speed, motor speed and electrical power consumption.

278 The tests could also include:

- replacement or make-up air supply;
- air temperature;
- filter performance.

279 The test records and calculations should enable easy comparison of volume flow rates, velocities and pressures with the specification. Where the system fails to deliver its design performance, detailed investigation and testing may be needed to reveal the causes of, and remedies for, the problem.

Stage 3 Control effectiveness

280 There are three general categories when assessing the effectiveness of LEV, although these can overlap:

- LEV of a design known to be effective;
- LEV design proven qualitatively to be effective;
- LEV design that appears to be adequate but control effectiveness is uncertain.

LEV of a design known to be effective

281 This is a proven, well-characterised LEV system known to control exposure adequately. Such systems must be:

- of a standard design;
- applied to standard processes in an industry;
- made to clear design specifications.

282 The commissioner should record the observed and measured performance data in the commissioning report. Where LEV effectiveness depends on operator

behaviour, make sure that the correct ways of working are also described. The data should appear in a commissioning report and benchmark data should be entered in the logbook for the system.

LEV design proven qualitatively to be effective

283 This is when the LEV system is shown to provide the required protection based on a careful observation of contamination sources and the hoods applied to them. When the system is examined using tests, such as smoke or a dust lamp, it works well. Such systems are less well characterised than 'LEV systems of a design known to be effective'. They require more careful commissioning, involving:

- close observation of sources and operator activities;
- smoke tests with the process running, with observation of smoke leakage, eddying and smoke encroachment into the operator's breathing zone;
- where the contaminant is dust or mist, dust lamp observation of the cloud behaviour with the process running;
- operator behaviour and the usability and sustainability of the control systems, observing that they are following agreed work methods.

284 Record all the LEV data that deliver adequate control, including the static pressure reading on every hood manometer. Where LEV effectiveness depends on operator behaviour, make sure that the correct ways of working are also recorded. The data should appear in a commissioning report and benchmark data should be entered in the logbook for the system.

285 A subset of this group is where the LEV appears to be effective but there are no commissioning data available, no user manual and no logbook for the system. The commissioner should then make measurements of pressure and airflow data for a new logbook.

LEV design that appears to be adequate but control effectiveness is uncertain

286 This is often the case where an LEV system must give stringent control, eg for toxic substances. The system may be operating at its design limits. Where LEV is not effective enough, the client may need a different control solution that may not involve LEV (eg a refuge). Process operators and workers nearby may require RPE.

287 Where control needs to be stringent, observational and other qualitative checks alone are usually insufficient to judge adequate control. Measurement such as air sampling will also be needed,

Qualitative assessment methods

Observation

288 The experienced commissioner is able to judge the likely effectiveness of systems by simple observation. However, the judgement requires testing and the findings need to be recorded. Observation includes judging the adequacy of make-up air. Inspection within ducts etc requires an endoscope, fibre-optic camera or borescope.

Making particle clouds visible

289 'Tyndall illumination' makes fine particles visible. The 'Tyndall effect' is the forward scattering of light. This is commonly seen when a shaft of sunlight entering a building shines through mist, dust or fume in the air. The 'dust lamp' reproduces this effect by producing a powerful parallel beam of light (see Figure 44). It shows the density and movement of particle clouds in its path. The user should move the lamp to illuminate different parts of the cloud and indicate the full cloud size and behaviour.²⁸

How to use a dust lamp

290 When using a dust lamp, do the following:

- Examine the work process. Where are the contaminant sources?
- Use the dust lamp on a tripod to light the potential source.
- Run the process.
- Stand off the axis of the light beam. Shielding your eyes from the lamp with an opaque barrier, look up the light beam. View the forward scattering of light from the particle cloud.

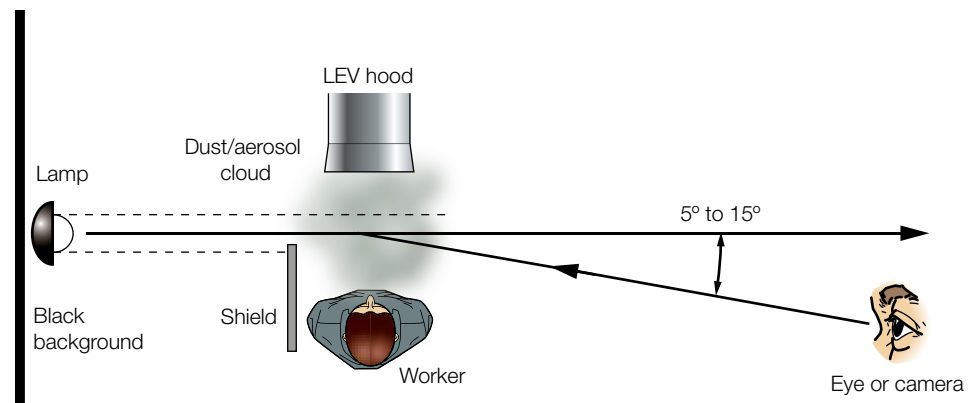

Figure 44 How to use a dust lamp

291 Also note:

- A tripod is essential for beam positioning.
- Rechargeable torches are available, suitable for use as a dust lamp.
- The dust lamp's parallel beam may only illuminate a part of the cloud.
- A dark background helps to reveal scattered light, eg a dark cloth.
- Turn out the workroom lights if you can as long as this creates no safety risk.

Making air movement visible using smoke

292 Smoke from pellets, smoke tubes or smoke generators can:

- show the size, velocity and behaviour of airborne contaminant clouds;
- identify capture zones and boundaries;
- confirm containment within a hood;
- identify draughts, their direction and size;
- show the general movement of air.

293 The choice of smoke generator depends on the type and size of the source and hood.

- Smoke tubes produce a small amount of smoke as a single cloud. Some produce an acidic mist. They are often useful for testing smaller hoods.
- Smoke generators can produce variable amounts of smoke for prolonged periods. They use oil, propylene glycol etc that can leave residues. They are usually unsuitable where smoke detectors are fitted, unless these can be isolated. Smoke generators have many uses, including assessing the effectiveness of large enclosing hoods.
- Smoke pellets produce a moderate amount of smoke for a short period. They are inappropriate with flammable substances nearby. They are useful for testing canopies and flues.

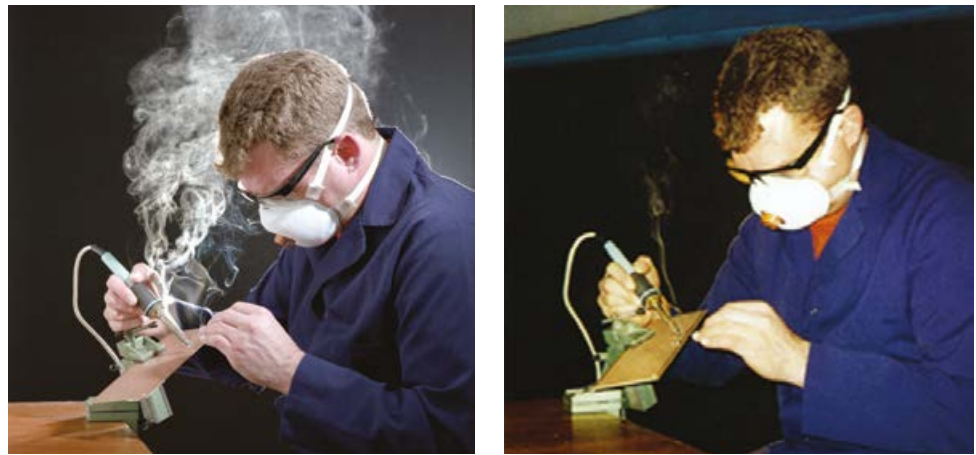

Figure 45 Soldering with and without Tyndall illumination

Quantitative assessment methods

294 Quantitative methods produce a reproducible measurement of performance. Measurements alone do not provide direct evidence of control effectiveness, but the records are available for future comparison as benchmarks. Methods include:

- measuring the flow rates at various points including hood faces and ducts, hood ducts and the main duct;
- measuring static pressures in various parts of the system including hood ducting and the pressure drop across filters and fans;
- the fan speed, motor speed and power consumption.

The types of tests and equipment

295 Measuring instruments should be calibrated. Use intrinsically safe instruments where there may be flammable atmospheres. The types of tests and equipment include:

- **Pressure testing** with a manometer (eg inclined, anaeroid or micro).
- **Air velocity testing** using an anemometer, eg thermistor or hot wire, velometer or a pitot tube.
- **Testing effectiveness** with aerosol generation, and tracer gases with a suitable detector.
- **Fan testing:** Equipment includes tachometers and power consumption meters.
- **Filter or air cleaner performance testing:** Equipment includes isokinetic and size-selective sampling, water quality test kit.

- **Observation:** Dust lamp, smoke-generation equipment, camera, fibre-optic camera and borescope (for internal LEV examinations).

Air sampling

296 Proof of effective control is the critical test. Air sampling, as required by COSHH may be appropriate. Sampling is carried out once all elements of the system are established, including correct operator behaviour. It generally requires a professional occupational hygienist, who makes:

- a careful choice of appropriate sampling methods;
- accurate measurements;
- a professional interpretation of the results.

297 Where the hazard and potential risk is great, and the sustained performance of the LEV is critical to exposure control, air sampling to measure exposure may be needed. This should be conducted in accordance with a suitable procedure as required by COSHH. Air sampling means a combination of static samples near, and at a distance from, the hood; personal sampling (operator and others); and emission sampling, as appropriate.^{29,30}

Stage 4 Reports

298 Data on test points and design performance should also appear in the LEV user manual. The schedule for checks and maintenance should appear in the logbook.

LEV commissioning report

299 This is produced by the LEV commissioner and contains the key results of the LEV system commissioning. It provides a reference against which to compare regular checks and maintenance and statutory thorough examination and testing (see Chapter 10). The commissioning report confirms that the LEV system is performing as designed and that, in the commissioner's professional opinion, the system delivers adequate control of exposure.

300 The report should be clear and show all relevant calculations. This enables volume flow rates, velocities and pressure measurements to be compared with the design specification. Any mismatch shows a need to alter the LEV performance (eg change damper settings) to bring it back into specification. This is not necessarily simple. It may be that only diagnostic testing can identify the defect.

301 The commissioner should enter relevant information on performance, such as pressure and velocity measurements in the LEV user manual, and the benchmark findings of commissioning into the logbook for the system.

302 Where the effectiveness of the system depends on how it is used, the required procedures and practices need to be recorded in the user manual and the commissioning report.

Report contents

303 The report should contain:

- diagrams and a description of the LEV, including test points;
- details of the LEV performance specification;

- results, such as pressures and velocities at stated points;
- calculations;
- a written description of the commissioning, the qualitative and quantitative tests undertaken, and the outcome. Where necessary, this should include air sampling results;
- a description of operator behaviour for optimum LEV effectiveness.

Table 17 Principles of commissioning

| | |
|--|---|
| Installation | <p>Install according to the design specification</p> <p>Check the layout and components against the plan</p> <p>Agree any modifications with the designer/supplier</p> <p>Check active parts of the system work (eg fan, air cleaner)</p> <p>Check a multi-branch system is (roughly) balanced</p> <p>Record any variations</p> <p>Include accessible cleaning and testing points</p> |
| Safe working procedures | <p>Agree safe working procedures and responsibilities with the employer</p> <p>Make sure any assessments and permits are in place, eg COSHH assessments and permits-to-work</p> <p>Modify standard risk assessments covering on-site work</p> |
| Technical performance | <p>Check the installation is correct and according to the design plan</p> <p>The performance of hood, duct, air cleaner, air mover and discharge should all be correct. Make qualitative and quantitative checks</p> <p>Balance a multi-branch system</p> |
| Control effectiveness | <p>Verify the effectiveness of control</p> <p>Check against installation and technical performance</p> <p>Check operators are following correct ways of working</p> <p>Make qualitative and quantitative checks to assess control effectiveness</p> |
| Commissioning report | <p>Needs to be detailed enough</p> <p>Agree this with the employer – this is part of the contract</p> |
| Transfer relevant data to the user manual and logbook | <p>This should be part of the contract</p> <p>Documents should have space for relevant results and observations</p> <p>Identify benchmarks and enter them in the manual for the system</p> |

Chapter 9 User manual and logbook

Key point

- HSE guidance to employers is to request both a 'user manual' and a 'logbook' from LEV system suppliers.

304 This chapter describes essential documentation for LEV systems.

Introduction

305 The manufacturer should supply suitable instructions as part of the design, installation and commissioning process. There should also be instructions on how to operate the system safely, maintain it correctly and examine it thoroughly. The instructions should be in English.

306 The instructions should contain the business name and full address of the manufacturer and of the manufacturer's authorised representative. They should also contain the designation of the machinery as marked on the machine but not necessarily the serial number. They should also contain a copy of the EC declaration of conformity (DOC) or a similar document setting out the contents of the EC DOC.

User manual

307 A manual should cover how to use the system, how to maintain it, the spares available and a list of things that can go wrong. It should contain an exploded diagram naming key components of the LEV.

308 The employer, as owner of the LEV system, requires a user manual because:

- they may not understand the technicalities of the LEV system;
- LEV checking and maintenance will improve with good instructions and guidance;
- it will assist the examination and test of the LEV system.

309 A user manual for LEV should preferably be in two parts:

- simple 'getting started' instructions (to be read by most people);
- detailed technical information for service providers and maintenance/repair engineers.

310 The detailed technical information should include:

- the purpose and description of the LEV system, including diagrams and drawings;
- how to use the LEV;
- signs of wear and control failure;
- the schedule, frequency and description of checks, maintenance and replacement;

- a detailed description of the specific statutory ‘thorough examination and test’ requirements and benchmarks;
- the performance information from commissioning;
- a listing of replaceable parts (and part numbers).

Purpose

311 There should be a description of what the LEV system is designed to control and how it achieves control.

Detailed description

312 The detailed description should include:

- component specification and materials of construction and component serial numbers;
- the designed face velocities of all hoods and the duct velocities. Where the system components have ‘type test’ reports, these should be included;
- make-up air arrangements;
- the measurement and test points and the measurements and tests required. This includes testing alarms; for systems that use water, it includes tests of water quality; and, where necessary, tests also include light levels at the work position;
- maintenance and cleaning frequencies, eg fan blades, filters;
- checks for articles blocking LEV and how to avoid contaminant build-up;
- correct operator behaviour in using the system, eg moveable hood positioning in relation to a source;
- any special requirements for waste disposal.

Drawing

313 A drawing of the system should include identified components and, where appropriate, their serial numbers, showing:

- hoods, including air inlets and, if appropriate, their capture zone;
- ductwork runs (rigid and flexible), bends and junctions, contractions and expansions;
- control dampers and valves;
- monitoring equipment, eg manometers;
- measurement and test positions and (if necessary) sampling positions;
- access hatches;
- air cleaner (if fitted);
- air mover;
- discharge;
- monitors and alarms.

Operation and use

The details of operation and use could include:

- identification of adjustable controls that affect the system’s performance, eg dampers;
- the position of hoods, sash openings etc for optimum performance;
- operator practice, including positioning of process equipment and methods of working (this needs consultation with the employer and employees);
- other factors affecting LEV performance, such as draughts from open doors or the use of additional fans for cooling.

Checking and maintenance

315 The details of checking and maintenance should include:

- ductwork condition, especially flexible ducts;
- mechanical integrity, eg corrosion, damage, seals, dampers, sash suspensions etc;
- cleanliness of hoods, especially canopies and duct interiors;
- operation of monitors, airflow indicators etc;
- pressure relief or inerting systems, if applicable;
- test for leakage;
- illumination in booths and hoods;
- noise levels;
- alarm systems operate correctly;
- water quality if appropriate;
- make-up air without draughts or blockages;
- list of spare parts required.

Thorough examination and testing

316 The details of thorough examination and testing should include:

- what to test;
- when to test;
- where to test;
- how to test;
- comparison with commissioning and subsequent test results where available.

Technical performance

317 Where available, the details of technical performance should include:

- static pressure target values for each hood, duct, and other identified points in the system;
- target hood face velocity and other velocities;
- the operators' (employees') exposure compared with exposure benchmarks.

LEV system logbook

318 An LEV system logbook will contain schedules and forms to keep records of regular checking, maintenance and repair. The logbook contains:

- schedules for regular checks and maintenance;
- records of regular checks, maintenance, replacements and repairs;
- checks of compliance with the correct way of working with the LEV system;
- the name of the person who made these checks.

Examples of what could appear in the logbook's checklists

319 Identified daily checks, weekly checks and monthly checks for each item in the system, for example:

- hoods, including airflow indicators, physical damage and blockages;
- ducts, including damage, wear and partial blockage;
- dampers – position;

- air cleaner, including damage, static pressure across the cleaner, and failure alarms;
- air mover, including power consumption and changes in noise or vibration;
- maintenance carried out;
- replacements made;
- planned and unplanned repairs;
- operator's use of the LEV – check they are following correct procedures;
- space to report the results against each check item;
- signature and date.

320 Specific examples include:

- clearance time for a room enclosure or booth;
- receiving hood positioning, particularly for moveable hoods;
- capturing hood and working zone within the capture zone;
- operator making sure the source is well within a partial enclosure;
- operator working sideways-on to the airflow in a walk-in booth;
- clutter obstructing LEV;
- checking the fan noise and keeping the impellers clean;
- fan bearing replacement;
- filter material replacement.

Undocumented existing systems

321 For LEV systems with no instructions or logbook, the employer should first approach the manufacturer for assistance. If this is unsuccessful, the employer may request assistance from an expert, eg a consultant engineer or occupational hygienist specialising in LEV to prepare suitable documentation.

322 The methods used to judge whether the LEV continues to achieve the original performance and provides adequate control will depend on the assessment of the system but would normally include visual, pressure measurements, airflow measurements, dust lamp and air sampling tests, as appropriate (see paragraphs 288–297).

Chapter 10 Thorough examination and test

Key points

- Every employer's LEV system requires statutory 'thorough examination and testing' by a competent person.
- The examination and testing report should have a prioritised list of any remedial actions for the employer.
- The employer's engineer and person responsible for health and safety both should see the report.

323 This chapter describes the statutory examination and test required for LEV systems. It supplements guidance in the COSHH ACOP and guidance.

Introduction

324 Routine checks (daily, weekly and monthly) keep the LEV system running properly. The frequency of routine checks and their description should be set out in the system logbook. A trained employee is able to make routine checks. Employees should report any defects in LEV to their supervisor. The employer must make sure that those who check or examine LEV have the right combination of skills, experience and knowledge, ie they are competent.

325 COSHH requires maintenance, examination and testing of control measures. This includes thorough examination and testing of engineering controls at intervals so that controls remain effective at all times. 'Controls' mean more than just the 'hardware' and include:

- engineering controls, including LEV;
- systems of work and supervision.

326 The thorough examination and test can be used by an employer as an audit of the past year's LEV system management. The objective of testing is to detect significant defects and to have them remedied to maintain control.

Thorough examination and test

327 A thorough examination and test is a detailed and systematic examination sufficient to make sure that the LEV can continue to perform as intended by design and will contribute to the adequate control of exposure. The thorough examination would normally include such functional testing to provide sufficient evidence to indicate adequate control is being achieved. The thorough examination and test is carried out by a person who is competent and able to make an objective assessment of the LEV. This can be:

- an outside contractor; or
- a competent employee of the LEV owner (the employer).

328 Information on the 'competence' of the LEV examiner appears in Chapter 2 and Appendix 1.

Frequency of thorough examination and test

329 The maximum time between tests of LEV systems is set down in COSHH and for most systems this is 14 months (see the exceptions in Table 18). If wear and tear on the LEV system is liable to mean that the system effectiveness will degrade between tests then thorough examinations and tests should be more frequent.

Table 18 Legal maximum intervals for thorough examination and test of LEV plant used in certain processes (COSHH Schedule 4)

| Process | Minimum frequency |
|--|-------------------|
| Processes in which blasting is carried out in or incidental to the cleaning of metal castings in connection with their manufacture | 1 month |
| Jute cloth manufacture | 1 month |
| Processes, other than wet processes, in which metal articles (other than gold, platinum or iridium) are ground, abraded or polished using mechanical power in any room for more than 12 hours a week | 6 months |
| Processes giving off dust or fume in which non-ferrous metal castings are produced | 6 months |

330 In practice, some of these intervals may be helpful in suggesting suitable reduced intervals for testing of similar processes, eg abrasive blasting of articles other than castings: one month.

331 Although not necessarily part of the thorough examination process, there should be regular reviews of systems of work and behavioural controls (including supervision).

Preparing to check, maintain, repair and examine LEV

332 The LEV examiner must know the risks from the system under test. These include:

- health risks from residues within the systems;
- safety risks from mechanical parts of the LEV, work at height, electricity, manual handling and moving vehicles.

333 The employer and examiner should co-operate to ensure minimal risk for both service provider and employees (operators) who may be affected by the work. The employer should arrange for permits-to-work (where necessary) and safe access. The employer should also provide information about personal protective equipment requirements.

334 For statutory thorough examination and test the examiner should, where available, use the following information sources:

- the LEV system commissioning report;
- the LEV user manual;
- the logbook for the system;
- the previous thorough examination and test report;

- any employer records of air sampling relevant to LEV performance and information on the way operators use the LEV;
- confirmation that there have been no changes to the LEV, layout or process since the last test.

335 The examiner should verify that the documents apply to the system under test. If none of these documents are available, the employer could request the examiner to also carry out a commissioning report that provides sufficient detail to produce information for a user manual. This additional service, and any costs, would need to be agreed between the client and the examiner.

Carrying out a thorough examination and test

336 The examination and test procedure and methods are similar to the original commissioning exercise, with similar qualitative and quantitative methods. Thorough examination and testing of LEV can be considered to comprise three stages:

Stage 1 A thorough visual and structural examination to verify the LEV is in efficient working order, in good repair and in a clean condition.

Stage 2 Review of the technical performance to check conformity with commissioning or other sources of relevant information.

Stage 3 Assessment of control effectiveness.

337 LEV examiners must have the appropriate equipment such as Pitot tubes, a smoke generator, a dust lamp, an anemometer and, sometimes, equipment for air sampling.

Stage 1 Thorough visual and structural examination

338 This should include, as appropriate:

- thorough external examination of all parts of the system for damage, wear and tear;
- internal duct examinations;
- checks that any filter cleaning devices (eg shake-down, reverse or pulsed jet) work correctly;
- inspection of the filter fabric. Where filters have built-in pressure gauges, checks on their function (and that the operating pressure is correct);
- checks of the water flow and sump condition in a wet scrubber;
- checks that the monitors and alerts/alarms are functioning correctly;
- inspection of the air mover drive mechanism, eg fan belt;
- checks for indications of effectiveness. Are there significant deposits of settled dust in and around the LEV hood? Is any part of the system vibrating or noisy?

Stage 2 Review technical performance

339 This may include, as appropriate:

- careful observation of processes and contaminant sources;
- challenge tests with smoke with the process running, to check for effective control considering smoke leakage, eddying and breathing zone encroachment. The examiner should warn employees and may need smoke alarms turned off;

- dust lamp tests with the process running to check for escape of dust or mist;
- measurements which may include, as appropriate:
 - airflow velocity measurements (eg indicated in the system documentation). This includes hood faces, branch ducts and the main duct;
 - static pressure measurements at suitable (appropriately marked) test points indicated in the system documentation. This includes all hoods, ducting, across the air cleaner and fan;
- checking the fan speed, motor speed and electrical power consumption;
- checking direction of rotation of the fan impeller;
- checking the replacement or make-up air supply;
- testing alarms, by simulating a failure, and the alarm's ability to detect the failure;
- measuring air temperatures;
- testing the air cleaner performance (eg a recirculating system).

340 Environmental legislation may require testing of air discharges but this is not covered by this book.

341 The examiner should calculate volume flow rates. The next steps are:

- to compare the results of testing with the LEV design specification as reported in system documentation such as the user manual or other sources of performance standards;
- to diagnose the causes of discrepancies. With the employer's consent the examiner may, where possible, make simple alterations that restore the required performance. An example is where displaced dampers cause a multi-branch system to be out-of-balance – the examiner may rebalance the system.

342 If the system is unsafe, the examination should stop until the system has been repaired and its original performance restored. The examiner should warn the client promptly.

Stage 3 Assess control effectiveness

343 The purpose of the thorough examination and test is to make sure that the LEV can continue to perform as intended by design and will contribute to the adequate control of exposure. The examiner needs to have carried out:

- a visual and structural examination;
- careful observations of the process and contaminant sources and the way in which operators use the LEV;
- suitable challenge tests;
- appropriate measurements as detailed;
- comparison of measurements made with any employer records of air sampling relevant to LEV performance and information on the way operators use the LEV.

344 If the above criteria are met and are acceptable then contaminant control should in nearly all circumstances be adequate and a test certificate issued.

Marking hoods

345 The employer should ask the examiner to attach a test label to each hood when tested (see Figure 46), where appropriate. This is an effective way of providing information on whether or not an examination has been done or when it's due. Supervisors and operators, as well as employers, also need to know when a

hood (or LEV system) has failed. Attaching a 'fail' label (see Figure 47) is an effective way of easily providing this information.

Test record:

| | |
|-----------------|--|
| Test date | |
| Next test | |
| Examiner | |

Figure 46 A test label for an LEV hood

Inadequate control:

| | |
|-----------------|------|
| Test date | FAIL |
| Examiner | |

Figure 47 A fail label for an LEV hood

346 The criteria for a red label are:

- reduced or no detectable airflow;
- failure of an enclosing hood to contain the contaminant cloud;
- failure of a receiving hood to intercept or contain the contaminant cloud;
- failure of a capturing hood, eg the capture zone does not encompass the working zone.

347 It may be useful to use a red label for other parts of the LEV system that have clearly failed.

Report of LEV thorough examination and test

348 The examiner judges whether the system is contributing effectively to the employer's overall strategy for controlling exposure to substances hazardous to health and produces a prioritised plan for any actions. The employer should understand what actions are required and, if these are uncertain, contact an LEV supplier for expert help. Where maintenance or repairs are identified as priorities for action, the employer should plan and schedule such repair and retest to assure control.

349 A suitable employer record in respect of each thorough examination and test of LEV should normally contain the following details:

- the name and address of the employer responsible for the LEV;
- the date of the thorough examination and test;
- the date of the last thorough examination and test;
- the identification and location of the LEV and the process and hazardous substance(s) concerned;
- the operating conditions at the time of the test and whether this was normal production or special conditions;

- a simple diagram of the LEV layout and location, with test points;
- the general condition of the LEV system, including hood serial numbers and, where appropriate, photographs of relevant parts;
- information about the LEV plant which shows:
 - its intended operating performance for adequately controlling the hazardous substance(s) for the purposes of COSHH regulation 7. (Note: If there is no information available on this, it indicates a need for a further assessment in accordance with COSHH regulation 6 to show compliance with COSHH regulation 7);
 - whether the plant is still achieving the same performance;
 - if not, the adjustments, modifications or repairs needed to achieve that performance;
- the methods used to judge performance and the action to be taken to achieve that performance, eg visual, smoke test, airflow measurements, pressure measurements, dust lamp, air sampling, tests to check the condition and effectiveness of the filter;
- the results of any air sampling relevant to LEV performance;
- information on the way operators use the LEV;
- information on general system wear and tear and whether components may need repair or replacement before the next test;
- the name, job title and employer of the person carrying out the examination and test;
- the signature of the person carrying out the examination and test;
- any minor adjustments or repairs carried out to make the LEV system effective;
- any critical defects identified.

350 The employer should keep the examination and test report for at least five years. A copy should be available at the workplace containing the LEV system.

351 Where the LEV system was previously undocumented, the record should be a suitable basis for a system manual.

Some LEV measurement methods

352 A variety of qualitative and quantitative methods can be used to assess LEV. Some are described below. Follow the LEV manufacturer's instructions, where appropriate.

Full enclosures

353 Measure the static pressure between the interior of the enclosure and the workroom. The pressure in the interior must be lower than the workroom.

Partial enclosures – Booths/fume cupboards

354 Measure the face velocity (see Figure 48). Readings should not vary excessively. Fume cupboards and microbiological safety cabinets should also be further tested according to appropriate British or European standards.

Receiving hoods including canopies and capturing hoods

355 Measure the face velocity. For larger hoods, measure at several points over the face. Readings should not vary excessively.

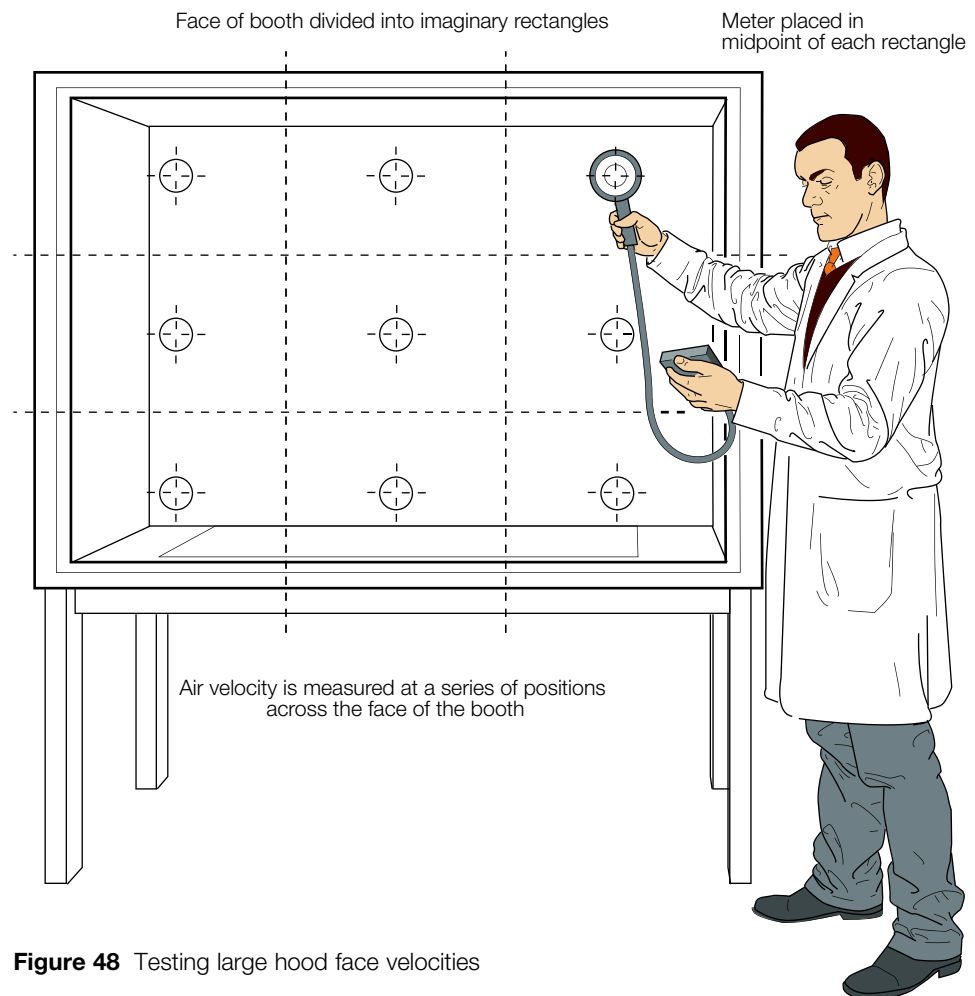

Figure 48 Testing large hood face velocities

Capturing hoods – Slots

356 Measure the air velocities at equidistant points along the entire length and average the readings. Readings should not vary excessively.

Hood static pressure

357 Measure the hood static pressure. If an airflow monitor is fitted, check the reading is correct.

Plenums

358 Measure the static pressure of the plenum (the enclosure behind certain types of hood) as well as the hood duct measurement.

Ducts

359 Measure the air velocity in the duct serving each hood, where this is possible. Measure in a straight section of duct – the measuring point should be well downstream of bends and other turbulence sources.

Fan/air mover

360 Measure the static pressure at the fan inlet and the volume flow rate. Measure the volume flow rate either on the fan inlet or outlet, wherever there is a reasonably straight section of duct – the measuring point should be well downstream of bends

and other turbulence. For a belt-driven fan, measure the rate of revolution of the fan shaft with a tachometer. See manufacturer's instructions.

Filters

361 Measure the static pressure across the filter. Where a fabric filter has a shake-down cleaning device, operate the shake-down before taking measurements. If the air volume passing through the filter is the same as that through the fan, the filter flow rate need not be measured.

362 Check the functioning and accuracy of any fitted pressure gauges.

Special filter

363 Filtration of 'toxic' particles requires a high performance filter, for example high efficiency particulate air ('HEPA' or 'absolute' filters). Follow an appropriate British, European or ISO standard to test such filters *in situ*.

Wet scrubber

364 Measure the static pressure at the inlet and outlet, and the water pH if relevant to the scrubbing performance.

Appendix 1 Legal requirements

1 This appendix summarises the legal duties placed on those concerned with LEV (including manufacture, supply, commissioning, use, maintenance, testing etc). For more details, look at relevant HSE publications.^{4,5,7} It does not cover legal matters relating to flammability (DSEAR⁸) or environmental legislation.

Who has responsibilities?

2 Health and safety law is aimed mainly at employers and, to a lesser degree, the self-employed, employees and others. The responsibilities of the self-employed, with regard to LEV systems, are the same as for employers where those self-employed whose work activity with hazardous substances poses a risk of harm to others and, for brevity, the use of the term 'employer' in this guidance also includes the self-employed in such situations.

3 Under the Health and Safety at Work etc Act 1974 (the HSW Act),³ every employer has health and safety duties to themselves, their employees and other people who may be affected by the way they carry out their work ('conduct their undertaking'). It is important to remember that companies who sell LEV or provide related services are also subject to duties under health and safety law (eg sections 3, 6 and 36 of the HSW Act). This means that anyone who, for example, supplies, installs, commissions or tests LEV has health and safety duties with respect to the people who use it (or are meant to be protected by it). Consequently, it is not just the owner of an LEV system who has responsibilities.

4 The HSW Act also takes account of offences which are primarily the fault of other people. For example, a client company may have employed the services of what they could justly assume was a competent person (see Chapter 2 and paragraphs 12–16 of this appendix for information on competence) to assess health risks, commission LEV etc. If the actions (or following the advice) of the competent person exposes the client's employees to a health risk, this could leave the client in breach of the law. Under the HSW Act, however, the competent person could be charged with the offence (irrespective of whether the proceedings are taken against the client) because the competent person was the real cause of the breach being committed.

5 The Control of Substances Hazardous to Health Regulations 2002 (COSHH) (as amended)⁴ add specific requirements to the generality of the HSW Act. For example:

- Employers must assess the degree of exposure and the risks to their employees, devise and implement adequate control measures, and check and maintain them.
- Employees must use these control measures in the way they are intended to be used and as they have been instructed.
- Employers must ensure that the equipment necessary for control is maintained 'in an efficient state, in efficient working order, in good repair and in a clean condition'.
- Employers must ensure that thorough examination and testing of their 'protective'* LEV is carried out at least every 14 months (unless otherwise stipulated), other engineering controls at 'suitable intervals' and must 'review and revise' ways of working so that controls are being used effectively.

* LEV may have been required for reasons other than COSHH, eg removal of unpleasant odours.

- The frequency of examination and tests should be linked to the type of engineering control in use, the size of the risk if it failed or deteriorated and how likely it is to fail or deteriorate.
- Employers and employees should give the person carrying out the thorough examination and test all the co-operation needed for the work to be carried out correctly and fully.
- Any defects should be put right as soon as possible or within a time laid down by the person who carries out the examination.
- The person carrying out the thorough examination and test should provide a record, which needs to be kept by the employer for at least five years (see Chapter 10 for what this should include).

Safety of machinery

6 The Provision and Use of Work Equipment Regulations 1998 (PUWER)³¹ apply to LEV systems and their components when used at work. LEV as work equipment should be suitable for its intended purpose, maintained for safety and conform at all times with any essential requirements that applied when first put into service. Many LEV systems are also machines with dangerous parts (motors, fans, rotary valves etc) for which adequate safety measures must be taken.

7 From an LEV perspective, relevant equipment and systems may include:

- emission generators, such as machines for turning, grinding and drilling that emit dust and metalworking fluid mist;
- emission controllers, such as LEV hoods, moveable and fixed extraction equipment (some of these fall within the 'machinery' definition, some may be 'safety components' as defined by the Directive, and so within scope);
- general equipment associated with a need for dust control where an activity may create a contaminant cloud, such as bag weighing at a bag filling station.

8 The Machinery Directive (2006/42/EC) applies to the design and construction of machinery and safety components independently placed on the market. The 'responsible person' (the manufacturer or authorised representative) must ensure that the relevant essential health and safety requirements (EHSRs) are met. This includes machinery being supplied with all the special equipment and accessories essential to enable it to be used safely. Information for putting machinery or safety components into service and for use must be provided, together with a Declaration of Conformity, and the CE mark affixed.

9 If a machine is to be part of an existing assembly, and so supplied as partly completed machinery, the supplier may only need to specify an extraction rate which needs to be achieved. The machine owner is then responsible for ensuring extraction is adequate to control exposure and the complete machine is safe when they combine the partly complete machinery in the existing assembly. However, where general equipment is supplied and the nature of the substance is unknown and unforeseeable, there may be no requirement to design/provide LEV.

10 The Supply of Machinery (Safety) Regulations 2008 (SMSR),⁷ which implement the Machinery Directive, require that machinery placed on the market, or put into service, is safe. Where suppliers are not the responsible person they must meet the obligations placed on them by section 6 of the HSW Act: to ensure, so far as reasonably practicable, that articles [for use at work] are designed and constructed to be safe and without risk to health at all times when being set, used, cleaned or maintained by a person at work. Section 6 will also apply to components not within scope of the Machinery Directive.

11 The ATEX Directive 94/9/EC (Equipment and protective systems intended for use in potentially explosive atmospheres) may also apply to the design and construction of dust handling equipment where there are risks from fire and explosion due to the nature of the material handled by the equipment. User obligations from the fire and explosion risks associated with LEV systems are covered by DSEAR.⁸

Competence

12 The Management of Health and Safety at Work Regulations 1999 (MHSWR)³² state that ‘an employer should be competent for health and safety purposes or employ or obtain advice from competent people’. This will include, for instance, anyone who:

- designs or selects control measures;
- checks, tests and maintains control measures;
- supplies goods and services to employers for health and safety purposes.

13 MHSWR also states that ‘people are seen as competent where they have enough training and experience or knowledge and other qualities to enable them ‘properly to assist in undertaking the measures referred to’.

14 Simple situations may require only:

- an understanding of what is required for compliance;
- an awareness of the limitations of one’s own experience and knowledge;
- the willingness and ability to supplement existing experience.

15 More complicated situations will require the competent person to have a higher level of skills, experience and knowledge. Employers are advised to check these are sufficient for the work they carry out.

16 COSHH requires that:

- employers make sure any person (whether or not their employee) who carries out work in connection with the employer’s duties under COSHH has suitable and sufficient information, instruction and training;
- employers ensure whoever provides advice on the prevention or control of exposure is competent to do so;
- whoever designs control measures needs appropriate knowledge, skills and experience;
- anyone who checks on the effectiveness of any element of a control measure should be competent to do so.

LEV competence: Design, supply, commission and test of LEV systems

17 Routes to becoming professionally competent include qualifications through BOHS, CIBSE and ILEVE. UKAS Accreditation for Commissioning of LEV or Thorough Examination and Test (TE_xT) of LEV is evidence that UKAS have audited the technical competence of a commissioning or inspection body. (See Chapter 2 and ‘Useful contacts’ section.)

Appendix 2 Selecting a ‘control benchmark’ and ‘control requirement’

1 This appendix describes a series of steps with worked examples to show how to assess a benchmark for the specification of LEV:

Step 1 Select the hazard band.

Step 2 Identify the exposure benchmark.

Step 3 Look at the ‘exposure matrix’.

Step 1 Select the hazard band

2 There are five hazard bands, A to E. A is the least hazardous and E is the most hazardous (see Step 2).

| Hazard band | Hazard classification | |
|-------------|---|--|
| | CHIP2* R-phrase numbers | GHS† H-phrase numbers |
| A | 36, 38, 65, 67 and all not otherwise listed | 303, 304, 305, 313, 315, 316, 318, 319, 320, 333, 336 and all not otherwise listed |
| B | 20, 21, 22, 68/20/21/22 | 302, 312, 332, 371 |
| C | 23, 24, 25, 34, 35, 37, 41, 43, 48/20/21/22, 39/23/24/25, 68/23/24/25 | 301, 311, 314, 317, 318, 331, 335, 370, 373 |
| D | 26, 27, 28, 40, 60, 61, 62, 63, 64, 48/23/24/25, 39/26/27/28 | 300, 310, 330, 351, 360, 361, 362, 372 |
| E | 42, 45, 46, 49, 68 | 334, 340, 341, 350 |

Example

You need to use the highest band in which any of the ‘R’ phrase numbers appear. A product classified as R20 R36/37/38 R65 is hazard band C, because R37 is in Band C. A product classified as R68/21/22 R43 is also hazard Band C. A product classified as R20/21/22 R68 is hazard band E.

* *Chemicals (Hazard Information and Packaging for Supply) Regulations 2002 (as amended) (CHIP) – Risk ‘R’ phrase.*

† *Globally Harmonised System (GHS) – Hazard ‘H’ phrase: interim hazard banding.*

Step 2 Identify the exposure benchmark

| Hazard of emitted material Band A to E | | Exposure benchmark range | |
|--|-----------------------------------|------------------------------------|-------------------|
| (COSHH essentials) | | Dust/mist | Vapour/gas |
| A | Unclassified as harmful | 1 to 10 mg/m ³ | 50 to 500 ppm |
| B | Harmful | 0.1 to 1 mg/m ³ | 5 to 50 ppm |
| C | Toxic, corrosive | 0.01 to 0.1 mg/m ³ | 0.5 to 5 ppm |
| D | Very toxic, toxic to reproduction | less than 0.01 mg/m ³ | less than 0.5 ppm |
| E | Carcinogen, mutagen, asthmagen | 'As low as reasonably practicable' | |

3 The benchmark should be the lower value in the exposure benchmark range.

Example

A product classified as hazard band C is associated with an exposure benchmark range between 0.01 to 0.1 mg/m³ (dust/mist) or 0.5 to 5 ppm (vapour/gas). The benchmark is either 0.01 mg/m³ (dust/mist) or 0.5 ppm (vapour/gas).

Control specification

4 *The technical basis for COSHH essentials*¹³ can identify a control solution. It uses an 'exposure matrix' that associates liquid volatility or dustiness with a typical exposure range and amount, assuming no controls are in place.

Liquid volatility

5 Boiling point or vapour pressure is the basis for selecting volatility:

- Low volatility liquids – vapour pressure less than 500 Pa.
- Medium volatility liquids – vapour pressure between 500 and 25 000 Pa.
- High volatility liquids – vapour pressure above 25 000 Pa.

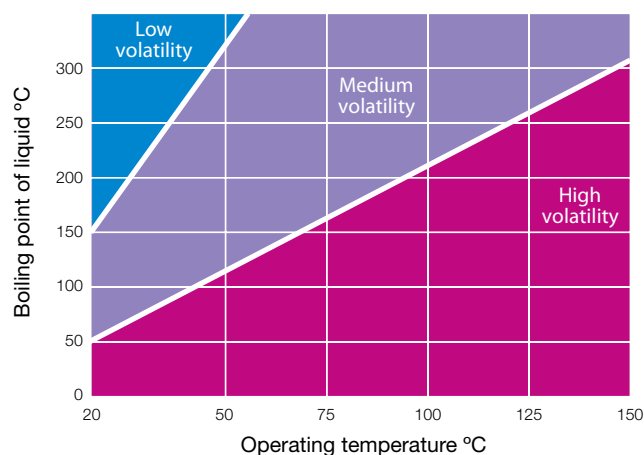

Figure 49 Graph to select volatility of liquid

6 Or select the volatility from the boiling point and process temperature (see Figure 49).

Solid dustiness

7 Judgement is the basis for selecting dustiness:

- Low dustiness solids – pellets and non-dusty solids.
- Medium dustiness solids – granules and coarse dusts.
- High dustiness solids – fine powders and solids that produce fine dust.

Amount

The amount is worked out as follows:

- **S:** Small amount – ml up to 1 litre (liquid); g up to 1 kg (solid).
- **M:** Medium amount – 1 litre up to 1000 litres (liquid); 1 kg up to 1000 kg (solid).
- **L:** Large amount – 1000 litres and above (liquid); 1 tonne and above (solid).

Step 3 Look at the ‘exposure matrix’

| | Liquid – Volatility | | |
|-----------|---------------------|--------|------|
| ppm | Low | Medium | High |
| > 500 | | | L |
| 50 to 500 | | M, L | M |
| 5 to 50 | M, L | S | S |
| < 5 | S | | |

| | Solid – Dustiness | | |
|-------------------|-------------------|--------|------|
| mg/m ³ | Low | Medium | High |
| < 10 | | L | L |
| 1 to 10 | | M | M |
| 0.1 to 1 | M, L | | |
| 0.01 to 0.1 | S | | |

Examples

A medium amount of a low volatility liquid is associated with an exposure range between 5 and 50 ppm.

A small amount of a high dustiness solid is associated with an exposure range between 0.1 and 1 mg/m³.

9 Recent research suggests that for sprayed liquids the vapour concentrations in the matrix should be:

| ppm | Sprayed liquid – Volatility | | |
|-----------|-----------------------------|--------|------|
| | Low | Medium | High |
| > 500 | – | M, L | M, L |
| 50 to 500 | M, L | – | – |
| 5 to 50 | – | S | S |
| < 5 | S | – | – |

10 The predicted exposure is the higher value in the exposure range (from Step 3). The control specification is derived from comparing a known or predicted exposure with the exposure benchmark (from Step 2).

Example: Known exposure limit and exposure

Rosin-core solder fume can cause asthma. It has a workplace exposure limit (WEL) at 0.05 mg/m³ (8-hour TWA) and exposure must be reduced as far as reasonably practicable below this limit, eg 0.01 mg/m³. Several mg/m³ of fume have been measured in solder fume smoke plumes. Given that solderers are close to the workpiece and that hot fume rises into the breathing zone, there is a need for LEV that reduces exposure one hundred-fold, ie fume at 1 mg/m³ reduced to 0.01 mg/m³ = 100-fold reduction.

Example: Unknown exposure limit and exposure

5 kg of a liquid toxic product is in hazard band C (Steps 1 and 2), associated with an exposure benchmark range at 0.5 to 5 ppm. With a boiling point at 270 °C and a process temperature at 130 °C: the product has medium volatility (Figure 49). Step 3 shows ‘liquid – medium amount – medium volatility’ associated with exposures between 50 and 500 ppm. There is a need for LEV that reduces exposure one thousand-fold, ie vapour at 500 ppm reduced to 0.5 ppm = 1000-fold reduction.

Glossary

| <i>Term</i> | <i>Alternative terms</i> | <i>Definitions; units</i> | <i>Comments; conversions</i> |
|-----------------------------|---|--|---|
| ACOP | | Approved Code of Practice. This carries greater legal weight in GB courts than 'guidance'. | Check the HSE website for status. |
| Aerodynamic diameter | Stokes diameter | The diameter of a unit-density sphere that has the same settling velocity in air as the particle in question. | Most workplace sampling is designed to size-select particles on aerodynamic diameter. |
| Air cleaner | Arrestor | A device to remove contaminants from air, eg filter, cyclone, sock, wet scrubber, electrostatic precipitator (EP). | |
| Air mover | Fan Propeller fan Axial fan Centrifugal fan Turbo exhauster | Devices that move air. | |
| Benchmarks | | Performance targets, eg flow-rate, pressure, degree of exposure. | |
| Boundary layer | | The stationary or turbulent layers of air near a surface which can hold a contaminant cloud. | |
| Breathing zone | | The region around operators from which they draw air for breathing. Commonly defined as being within 300 mm of nose/mouth. | See publication MDHS14/4. ¹⁰ |
| Canopy hood | | A receiving hood used over a hot process. | |
| Capturing hood | Capture hood Captor hood Exterior hood External hood | The source and the contaminant cloud are outside the hood. A capturing hood has to generate sufficient airflow at and around the source to 'capture' and draw the contaminant-laden air into it. | The capturing hood 'reaches out' to capture the contaminant cloud. |
| Capture velocity | | The air velocity (metres/second) required around a source to capture the contaminant cloud and draw it into the hood. | |
| Capture zone | | A 'three-dimensional envelope' in front of a capturing hood, in which the capture velocity is adequate. | |
| Clearance time | | The time taken for a contaminant to clear from a room or enclosure once generation has stopped. | |

| <i>Term</i> | <i>Alternative terms</i> | <i>Definitions; units</i> | <i>Comments; conversions</i> |
|-------------------------------------|---|---|---|
| Commissioning | Initial appraisal Intended operating performance Post-installation validation | Proof that an LEV system is capable of providing adequate control | In the past, adequate commissioning has been rare. |
| Contaminant cloud or draught | | The cloud of contaminated air that disperses from a source. | This may be as a jet, a plume, a puff, or a cloud of vapour evaporating gently. |
| Cyclone | | An air-cleaning device to remove particles from air by centrifugal force. | |
| Dilution ventilation | General ventilation | A supply of clean air into the workplace, mixing with contaminated air. | Forced dilution uses fans to move air around. |
| Displacement ventilation | Plug flow Piston flow | Clean air displaces the contaminated air with minimal mixing. | Rarely fully effective due to eddies etc. |
| Downstream user | | Under the REACH Regulation, someone (not the manufacturer or importer) who uses a substance in the course of their industrial or professional activities. | |
| Duct velocity | | The average air velocity measured on a duct cross-section (metres/second). | Equals the volume flow rate divided by the cross-sectional area. |
| Dust cake | | The layer of dust that builds up on a fabric filter. | Initially, this improves the filter performance but airflows reduce and filters can clog. |
| Dust lamp | Tyndall beam Tyndall lamp | A parallel light beam illuminates the dust cloud to produce forwards light-scattering | This enables the assessment of particle cloud size and movement |
| Duty point | | The point of intersection between the fan curve and the system resistance curve. | The duty point must be within the optimum range of the fan. |
| Eddy | | A region in airflow with a rotary motion, contrary to the main flow. | Always occurs at hood entrances. Smoothing entry can minimise. |
| Electrostatic precipitator | EP | A type of particle filter. Charged particles are attracted to a plate of opposite polarity, to which they attach. | |

| <i>Room enclosure</i> | <i>Alternative terms</i> | <i>Definitions; units</i> | <i>Comments; conversions</i> |
|----------------------------|--|--|--|
| Enclosing hood | Full enclosure Room enclosure Laminar flow rooms Laminar flow booths Enclosing room Clean room Cabin Booth Fume cupboard | A full enclosure contains the process. A room enclosure contains the process and the operator. A partial enclosure contains the process with openings for material and operator access. | Full and room enclosures: the degree of displacement ventilation determines personal exposure and the 'clearance time'. |
| Exposure limit | OEL WEL MAK IOELV DNEL PEL TLV® | OEL is the usual general acronym for occupational exposure limits. Workplace Exposure Limit (GB). Maximale Arbeitsplatz Konzentration (D). Indicative Occupational Exposure Limit Value (EC). Derived No Effect Level (EC; REACH). Permissible Exposure Limits (USA). Threshold Limit Values (US ACGIH). | TLV was the earliest OEL type and may still be the most widely used type of OELs. Most OELs refer to 8-hour and 15-minute TWAs. |
| Face velocity | | The average velocity of air at the open front face of a hood (metres/second). | Directly measured or calculated from the volume flow rate divided by the face area. |
| Fan curve | Fan characteristic curve | Graph of fan pressure, power and efficiency against volume flow rate. | |
| Flow rates | Linear flow rate Volume flow rate | Units of measurement Linear: metres/second Volume: cubic metres/second | 1 m/s = 197 ft/min 1 m ³ /s = 2119 cubic ft/min. |
| General ventilation | Ventilation General exhaust ventilation | Air extracted from a space as a whole and replaced. | Can be dilution, displacement or both, and may involve air movers. |
| Hood | | A device to enclose, receive or capture a contaminant cloud. | |
| Hood face | Hood entrance Hood inlet Note: Not the duct inlet at the back of the hood | The area at the entrance of a hood; the plane (or planes) between the workplace and the hood interior. For an enclosing hood, the face is all openings that are entry points for workplace air. | The hood face is not always obvious. The face is distinct from slots or filters at the back of a hood ('duct inlet'). While it is useful to measure duct inlet velocity, this must not be confused with face velocity. |
| Inhalable particles | Total inhalable dust Total dust Inspirable dust | 'That fraction of airborne material that enters the nose and mouth and is therefore available for deposition in the respiratory tract.' MDHS 14/4. ¹⁰ | Includes inspirable, tracheal and respirable dust fractions. |

| <i>Room enclosure</i> | <i>Alternative terms</i> | <i>Definitions; units</i> | <i>Comments; conversions</i> |
|--|--|--|--|
| LEV quotation | | The LEV that the supplier offers to deliver, including performance and price. | |
| LEV specification | | The employer's (as client) stated requirements for LEV. | See publication INDG408. ² |
| Lip extraction | Rim extraction | Extraction slot along one or more sides of an area source such as an open surface tank. | Inappropriate for tanks larger than 1.2 m wide. |
| Local air displacement (LAD) | Air jet Air blower Air shower/douche Air island | A wide, relatively slow-moving jet of air blown into the operator's breathing zone to displace contaminated air. | See Chapter 7 for details. |
| Local exhaust ventilation (LEV) | Local extract ventilation Extract ventilation Dust extraction Mist extraction Fume extraction Vapour extraction | The use of extraction to remove contaminated air at or near to its source. | |
| Low volume high velocity (LVHV) | On-gun extraction On-tool extraction Tip extraction (for soldering) | A method of LEV which uses very small hoods to capture contaminants very close to a source using high-velocity air extraction. | LVHV is usually fitted to hand tools. |
| Make-up air | Replacement air | Air to replace extracted air. | This is part of the LEV system. |
| Manometer | | A simple pressure-indicating device, eg on hoods. | In the past, adequate fitting of manometers has been rare. |
| Negative pressure | | Air pressure lower than that in the workplace. | |
| Piston flow/ Plug flow | Displacement ventilation | See 'Displacement ventilation'. | |
| Pitot tube | Pitot-static tube Prandtl tube | A device to measure static and total pressure. | |
| Plenum | Pressure equalising chamber | A device to smooth airflows, eg behind the filter in a walk-in booth or in an LAD system. | |
| Positive pressure | | Air pressure higher than that in the workplace. | |

| <i>Room enclosure</i> | <i>Alternative terms</i> | <i>Definitions; units</i> | <i>Comments; conversions</i> |
|--------------------------------|---|--|--|
| Pressure | | Units of measurement: Pascals (Pa) Torr = millimetre of mercury (mm Hg) Millibar (mbar) Pound per sq inch (psi) Inch water gauge (WG) | 1 mm Hg = 133 Pa 1 mbar = 103 Pa 1 psi = 7237 Pa 1 in WG = 249 Pa |
| Process | | The way that airborne contaminants are generated. | Understanding the process means understanding the creation of 'sources'. It can suggest ways to modify the process to reduce the number or size of sources and contaminant clouds. |
| Push-pull | Push-pull hood | An air supply on one side of a contaminant source blows the contaminant cloud towards an extraction hood on the other side. | The hood becomes a receptor. |
| Qualitative assessment | | Assessment by observation. | |
| Quantitative assessment | | Assessment by measurement. | |
| Receiving hood | Receptor hood Canopy A receiving hood is part of a push-pull system | A receiving hood receives a contaminant cloud, propelled into it with a 'vector' from the process. | Successful receiving hoods intercept contaminant clouds and contain them. |
| Respirable particles | | 'The fraction of airborne material that penetrates to the gaseous exchange region of the lung'. MDHS14/4. ¹⁰ | Dust below 10 microns (aerodynamic diameter). Invisible in normal lighting. |
| Risk management measure | RMM | LEV is a risk management measure under REACH. | Extended safety data sheets for substances and products will stipulate RMMs. |
| Slot | | A long, thin hood with an aspect ratio of 5:1 or greater. | |
| Source | | A process creates a source; the creation of the contaminant cloud. | |
| Source strength | | A combination of the volume rate of release of the contaminant cloud, the cloud volume, shape and speed and the contaminant concentration. | |
| Static pressure | Ps | Air pressure, measured normal to the flow direction, ie the difference between inside and outside air pressure measured by, eg, a manometer. | |

| <i>Room enclosure</i> | <i>Alternative terms</i> | <i>Definitions; units</i> | <i>Comments; conversions</i> |
|------------------------------|--------------------------------------|--|--|
| Time-weighted average | TWA | Airborne contaminant level averaged over a specified period, usually 8 hours or 15 minutes. | The 8-hour TWA is the averaged exposure over 24 hours, adjusted as if it were over 8 hours. |
| Total pressure | | The algebraic sum of the static and velocity pressures. | The pressure exerted by moving air, were it brought to rest. |
| Transport velocity | Conveying velocity | Air velocity to convey particles and prevent deposition in ducts. | |
| Turbulence | | Non-laminar air movement. | |
| Vapour pressure | | The pressure of a vapour in equilibrium with its liquid (or solid) phases. | 1 Pa = 9.86 ppm At 25°C, mg/m ³ = ppm x Mol.Wt / 24.45 |
| Vector | Velocity and direction | The speed and direction of a contaminant cloud or draught. | No/low vector, eg vapour from tank. High vector, eg dust jet from angle grinder. |
| Velocity pressure | Dynamic pressure (P _v) | Pressure exerted by air due to its motion. | The difference between the total pressure and the static pressure. |
| 'Vena contracta' | | The section within an opening at which the streamlines first becomes parallel after entering that opening. | |
| Wake | Turbulent wake Recirculation zone | A low-pressure region that forms downstream of a body in an airflow. | Complex airflow patterns can appear in the wake downstream of a worker. Contaminant can be drawn into the breathing zone. |
| Working zone | | The volume in the workplace where an activity is generating a contaminant cloud. | |

Useful contacts

American Conference of Governmental Industrial Hygienists (ACGIH)

www.acgih.org

American member-based organisation for occupational and environmental health, with many publications

American National Standards Institute (ANSI) www.ansi.org

Actionable information on national, regional, international standards and conformity assessment issues

American Society of Heating, Refrigerating and Air-Conditioning Engineers (ASHRAE) www.ashrae.org

International technical society of heating, ventilation, air-conditioning and refrigeration

British Occupational Hygiene Society (BOHS)

5/6 Melbourne Business Court, Millennium Way, Pride Park, Derby DE24 8LZ

Tel: 01332 298101 www.bohs.org

Incorporates the Faculty of Occupational Hygiene, which is an examining body in the field of LEV. The faculty publishes a Directory of Occupational Hygiene Consultants

British Standards Institution www.bsi-global.com

A leading global provider of management systems assessment and certification solutions

Chartered Institution of Building Services Engineers (CIBSE)

222 Balham High Road, London SW12 9BS

Tel: 020 8675 5211 www.cibse.org

For engineers designing heating, ventilation and air-conditioning services: also provides a path towards professional qualifications

Chemical Industries Association (CIA)

Kings Buildings, Smith Square, London SW1P 3JJ

Tel: 020 7834 3399 www.cia.org.uk

The UK trade association for the chemical industries

Confederation of British Industry (CBI) www.cbi.org.uk

Regionally organised, the CBI represents British industry

EEF – The Manufacturers’ Organisation

Broadway House, Tothill Street, London SW1H 9NQ

Tel: 020 7222 7777 www.eef.org.uk

Provides a range of health and safety services to members

Fan Manufacturers’ Association (FMA) www.feta.co.uk/fma

Principles and practice of air extract/supply system design; offers guidance on fan selection to ensure that such systems perform their intended function efficiently

The Federation of Environmental Trade Associations (FETA)

www.feta.co.uk

UK body representing the interests of manufacturers, suppliers, installers and contractors within the heating, ventilation, building controls, refrigeration and air-conditioning industry

Heating and Ventilating Contractors' Association (HVCA)

Esca House, 34 Palace Court, London W2 4JG

Tel: 020 7313 4900 www.hvca.org.uk

Represents the interest of firms active in design, installation, commissioning and maintenance of heating, ventilating, air-conditioning and refrigeration products and equipment

Independent National Inspection and Testing Association (INITA)

www.inita.org.uk

Represents independent companies that conduct inspection and certification of equipment, including LEV systems

Institute of Diagnostic Engineers (IDE) www.diagnosticengineers.org

Professional institute for people who are concerned with servicing and maintenance of machines and structures and effectiveness of engineering plant

Institution of Local Exhaust Ventilation Engineers (ILEVE) www.ileve.org

Formed to promote the science, understanding, education, art and practice of local exhaust ventilation engineering

Institution of Occupational Safety and Health (IOSH)

The Grange, Highfield Drive, Wigston, Leicestershire LE18 1NN

Tel: 0116 257 3100 www.iosh.co.uk

Leading body for health and safety professionals. Gives advice on choice of LEV systems

Safety Assessment Federation (SAFED)

Unit 4, First floor, 70 South Lambeth Road, Vauxhall, London SW8 1RL

Tel: 020 7582 3208 www.safed.co.uk

Trade association which represents the independent inspection and certification industry

Solids Handling and Processing Association (SHAPA) www.shapa.co.uk

Represents manufacturers, suppliers and installers for solids handling and processing industry

Trades Union Congress (TUC)

Congress House, Great Russell Street, London WC1B 3LS

Tel: 020 7637 4030 www.tuc.org.uk

Gives health and safety advice to members. (See also individual unions, eg UNITE www.unitetheunion.org)

UK Accreditation Service (UKAS)

2 Pine Trees, Chertsey Lane, Staines-upon-Thames TW18 3HR

Tel: 01784 429000 www.ukas.com

Accreditation of various professional activities, including competent LEV inspection bodies. UKAS accreditation scheme for 'LEV thorough examination and test' and 'LEV commissioning'

References and further reading

References

- 1 *Working with substances hazardous to health: A brief guide to COSHH* Leaflet INDG136(rev5) HSE 2012 www.hse.gov.uk/pubns/indg136.htm
- 2 *Clearing the air: A simple guide to local exhaust ventilation (LEV)* Leaflet INDG408(rev1) HSE 2015 www.hse.gov.uk/pubns/indg408.htm
- 3 *Health and Safety at Work etc Act 1974 (c37)* The Stationery Office 1974 ISBN 978 0 10 543774 www.legislation.gov.uk
- 4 *Control of substances hazardous to health (Sixth edition). The Control of Substances Hazardous to Health Regulations 2002 (as amended). Approved Code of Practice and guidance L5* (Sixth edition) HSE 2013 www.hse.gov.uk/pubns/books/l5.htm
- 5 *Managing for health and safety HSG65* (Third edition) HSE 2013 www.hse.gov.uk/pubns/books/hsg65.htm
- 6 Registration, Evaluation, Authorisation and restriction of CHemicals (REACH) www.hse.gov.uk/reach/index.htm
- 7 *Supply of Machinery (Safety) Regulations 2008* SI 2008/1597 The Stationery Office www.legislation.gov.uk
- 8 *Dangerous substances and explosive atmospheres: Dangerous Substances and Explosive Atmospheres Regulations 2002. Approved Code of Practice and guidance L138* (Second edition) HSE 2013 www.hse.gov.uk/pubns/books/l138.htm
- 9 *Managing health and safety in construction. Construction (Design and Management) Regulations 2015. Guidance on Regulations L153* HSE 2015 www.hse.gov.uk/pubns/books/l153.htm
- 10 *General methods for sampling and gravimetric analysis of respirable, thoracic and inhalable aerosols MDHS14/4* HSE 2014 www.hse.gov.uk/pubns/mdhs/index.htm
- 11 *Explosive atmospheres: Classification of hazardous areas (zoning) and selection of equipment* HSE www.hse.gov.uk/fireandexplosion/zoning.pdf
- 12 *Sizing of explosion relief vents* SHAPA Technical Paper 10 (revised) 2013 www.shapa.co.uk/technical.php
- 13 *The technical basis for COSHH essentials: Easy steps to control chemicals* HSE 2009 www.coshh-essentials.org.uk/assets/live/cetb.pdf
- 14 COSHH essentials: Easy steps to control health risks from chemicals www.hse.gov.uk/coshh/essentials/coshh-tool.htm
- 15 *Industrial ventilation: A manual of recommended practice for design* (29th edition) ACGIH 2016 www.acgih.org

- 16 *Ductwork (Heating, air conditioning and refrigeration)* CIBSE Guides 2016
www.cibse.org
- 17 *The Building Regulations 2000. Approved Document B. Fire safety* 2006 edition (amended) www.planningportal.gov.uk/buildingregulations/approveddocuments/
- 18 *Fire safety engineering* CIBSE Guide E www.cibse.org/knowledge
- 19 *Specification for sheet metal ductwork. Low, medium and high pressure/velocity air systems* DW/144 BESA (ex-B&ES) 2013 www.cibse.org/knowledge
- 20 *Specification for plastics ductwork* DW/154 BESA (ex-B&ES) 2002
www.cibse.org/knowledge
- 21 *Code of practice for resin-bonded glass fibre ductwork metric* DW/191 BESA (ex-B&ES) 1973 www.besapublications.com/Ecommerce/productPDFs/DW191.pdf
- 22 *Reference data (Heating, air conditioning and refrigeration)* CIBSE Guide C
www.cibse.org/knowledge
- 23 *Fan application guide (Ventilation and indoor air quality)* TM42 CIBSE 2006
www.cibse.org/knowledge
- 24 BS EN 14175-2:2003 *Fume cupboards. Safety and performance requirements*
British Standards Institution
- 25 *Controlling noise at work. The Control of Noise at Work Regulations 2005. Guidance on Regulations* L108 (Second edition) HSE 2005
www.hse.gov.uk/pubns/books/l108.htm
- 26 *Commissioning air systems* BG49 BSRIA 2015 www.bsria.co.uk
- 27 *Practices for measurement, testing, adjusting and balancing of building heating, ventilation, air-conditioning and refrigeration systems* Standard 111-1988
ASHRAE 1988 www.ashrae.org
- 28 *The dust lamp: A simple tool for observing the presence of airborne particles*
MDHS82/2 HSE 2015 www.hse.gov.uk/pubns/mdhs82.htm
- 29 *General methods for sampling* MDHS104 HSE 2016
www.hse.gov.uk/pubns/mdhs/index.htm
- 30 *Exposure measurement: Air sampling* G409 COSHH essentials: General guidance HSE 2006 www.hse.gov.uk/pubns/guidance/gseries.htm
- 31 *Safe use of work equipment. Provision and Use of Work Equipment Regulations 1998. Approved Code of Practice and guidance* L22 (Fourth edition) HSE 2014
www.hse.gov.uk/pubns/books/l22.htm
- 32 *The Management of Health and Safety at Work Regulations 1999* SI 1999/3242
The Stationery Office www.legislation.gov.uk

Further reading

A guide to energy efficient ventilation Liddament MW AIVC 1996 www.aivc.org

Industrial ventilation: A manual of recommended practice for design 29th edition ACGIH 2016 www.acgih.org

Fan and ductwork installation guide First edition HEVAC
www.feta.co.uk/downloads/listing.pdf Available from FETA, 2 Waltham Court, Milley Lane, Hare Hatch, Reading, Berkshire RG10 9TH

Handbook of ventilation for contaminant control Third edition Henry J McDermott 2001 ISBN 978 1 882417 38 4

Hemeon WCL *Plant and process ventilation* Third edition Lewis 1998
Edited D Jeff Burton ISBN 978 1 56670 347 5

Indoor air quality case studies reference guide George J Benda Editor Fairmont Press 1998 ISBN 978 0 88173 305 1

ANSI/AIHA standards

Exhaust systems for grinding, polishing, and buffing ANSI/AIHA Z9.6-1999
ISBN 978 0 932627 95 7 www.aiha.org

Fundamentals governing the design and operation of dilution ventilation systems in industrial occupancies ANSI/AIHA Z9.10-201 0 ISBN 978 1 935082 23 1
www.aiha.org

Fundamentals governing the design and operation of local exhaust ventilation systems ANSI/AIHA Z9.2-2006 ISBN 9781 931504 73 7 www.aiha.org

Laboratory ventilation ANSI/AIHA Z9.5-2003 ISBN 978 1 931504 35 5
www.aiha.org

Recirculation of air from industrial process exhaust systems ANSI/AIHA Z9.7-2007
ISBN 978 1 931504 79 9 www.aiha.org

Spray finishing operations: Safety code for design, construction, and ventilation
ANSI/AIHA Z9.3-2007 ISBN 978 1 931504 85 0 www.aiha.org

Ventilation and control of airborne contaminants during open-surface tank operations ANSI/AIHA Z9.1-2006 ISBN 978 1 931504 72 0 www.aiha.org

HSE publications

Controlling exposure to stonemasonry dust: Guidance for employers HSG201
HSE 2001 www.hse.gov.uk/pubns/books/hsg201.htm

EH40/2005 Workplace exposure limits: Containing the list of workplace exposure limits for use with the Control of Substances Hazardous to Health Regulations 2002 (as amended) Environmental Hygiene Guidance Note EH40 (Second edition)
HSE 2011 www.hse.gov.uk/pubns/eh40.htm

Controlling fire and explosion risks in the workplace: A brief guide to the Dangerous Substances and Explosive Atmospheres Regulations Leaflet INDG370(rev1)
HSE 2013 www.hse.gov.uk/pubns/indg370.htm

Confined spaces: A brief guide to working safely Leaflet INDG258(rev1) HSE 2013
www.hse.gov.uk/pubns/indg258.htm

Safe working with flammable substances Leaflet INDG227 HSE 1996
www.hse.gov.uk/pubns/indg227.htm

Time to clear the air! A workers' pocket guide to local exhaust ventilation (LEV)
Pocket card INDG409 HSE 2008 www.hse.gov.uk/pubns/indg409.htm

Noise at work: A brief guide to controlling the risks Leaflet INDG362(rev2)
HSE 2012 www.hse.gov.uk/pubns/indg362.htm

Further information

For information about health and safety visit <https://books.hse.gov.uk> or <http://www.hse.gov.uk>. You can view HSE guidance online and order priced publications from the website. HSE priced publications are also available from bookshops.

To report inconsistencies or inaccuracies in this guidance email: commissioning@wlt.com.

British Standards can be obtained in PDF or hard copy formats from BSI: <http://shop.bsigroup.com> or by contacting BSI Customer Services for hard copies only Tel: 0846 086 9001 email: cservices@bsigroup.com.

The Stationery Office publications are available from The Stationery Office, PO Box 29, Norwich NR3 1GN Tel: 0333 202 5070 Fax: 0333 202 5080. E-mail: customer.services@tso.co.uk Website: www.tso.co.uk. They are also available from bookshops.

Statutory Instruments can be viewed free of charge at www.legislation.gov.uk where you can also search for changes to legislation.